

INSTALLATION INSTRUCTIONS

S4BD SERIES - 018, 024, 030, 036, 042, 048, & 060 (1.5, 2, 2.5, 3, 3.5, 4, & 5 Ton)

IMPORTANT SAFETY INFORMATION	2	Refrigerant Charging.....	7
AIR CONDITIONER INSTALLATION	3	Charging the Unit in AC Mode with	
General Information	3	Outdoor Temperatures Above 55° F.....	8
Before You Install this Unit.....	3	Application Notes for Using Charging Charts	8
Locating the Air conditioner.....	3	S4BD CHARGING CHARTS	8
Packaging Removal	3	Figure 3. Charging Chart for 1.5 Ton Units.....	8
Ground Level.....	3	Figure 4. Charging Chart for 2 Ton Units.....	9
Roof Mount.....	3	Figure 5. Charging Chart for 2.5 Ton Units.....	9
Connecting Refrigerant Tubing between the		Figure 6. Charging Chart for 3 Ton Units.....	10
Indoor & Outdoor Unit	4	Figure 7. Charging Chart for 3.5 Ton Units.....	10
ELECTRICAL WIRING	4	Figure 8. Charging Chart for 4 Ton Units.....	11
Pre - Electrical Checklist	4	Figure 9. Charging Chart for 5 Ton Units.....	11
Line Voltage.....	4	S4BD CHARGING TABLES	12
Comfort Alert™ Diagnostics Module	5	Table 3. Charging Table for 1.5 Ton Units.....	12
24VAC Power Wiring	5	Table 4. Charging Table for 2 Ton Units.....	12
Thermostat Demand Wiring.....	5	Table 5. Charging Table for 2.5 Ton Units.....	13
Interpreting the Diagnostic LED's	5	Table 6. Charging Table for 3 Ton Units.....	13
LED Description	6	Table 7. Charging Table for 3.5 Ton Units.....	14
Grounding	6	Table 8. Charging Table for 4 Ton Units.....	14
Thermostat Low / Voltage Connections.....	6	Table 9. Charging Table for 5 Ton Units.....	15
AIR CONDITIONER MAINTENANCE	6	ELECTRICAL DIAGRAMS & TABLES	16
STARTUP & ADJUSTMENTS	7	Figure 10. W.D., Single Phase (1.5 - 5 Ton)	16
Pre - Start Checklist.....	7	Table 10. Comfort Alert LED Diagnostics.....	17
Start-up Procedures.....	7	Table 11. Module Wiring Troubleshooting.....	18
Air Circulation - Indoor Blower	7	INSTALL. / PERFORMANCE CHECKLIST	20
System Cooling	7	REPLACEMENT PARTS	20
System Heating.....	7		

IMPORTANT

ATTENTION INSTALLERS:

It is your responsibility to know this product better than your customer. This includes being able to install the product according to strict safety guidelines and instructing the customer on how to operate and maintain the equipment for the life of the product. Safety should always be the deciding factor when installing this product and using common sense plays an important role as well. Pay attention to all safety warnings and any other special notes highlighted in the manual. Improper installation of the furnace or failure to follow safety warnings could result in serious injury, death, or property damage.

These instructions are primarily intended to assist qualified individuals experienced in the proper installation of this appliance. Some local codes require licensed installation/service personnel for this type of equipment. Please read all instructions carefully before starting the installation. Return these instructions to the customer's package for future reference.

DO NOT DESTROY. PLEASE READ CAREFULLY & KEEP IN A SAFE PLACE FOR FUTURE REFERENCE.

IMPORTANT SAFETY INFORMATION

INSTALLER: Please read all instructions before servicing this equipment. Pay attention to all safety warnings and any other special notes highlighted in the manual. Safety markings are used frequently throughout this manual to designate a degree or level of seriousness and should not be ignored.

WARNING indicates a potentially hazardous situation that if not avoided, could result in personal injury or death.

CAUTION indicates a potentially hazardous situation that if not avoided, may result in minor or moderate injury or property damage.

WARNING:

Shut off all electrical power to the unit before performing any maintenance or service on the system. Failure to comply may result in personal injury or death.

WARNING:

Unless noted otherwise in these instructions, only factory authorized parts or accessory kits may be used with this product. Improper installation, service, adjustment, or maintenance may cause explosion, fire, electrical shock or other hazardous conditions which may result in personal injury or property damage

WARNING:

S4BD Split System Air Conditioners are shipped charged with R410A refrigerant and ready for installation. If repairs make it necessary for evacuation and charging, it should only be attempted by qualified trained personnel thoroughly familiar with this equipment. Under no circumstances should the owner attempt to install and/or service this equipment. Failure to comply with this warning could result in property damage, personal injury, or death.

CAUTION:

This unit uses refrigerant R-410A. DO NOT use any other refrigerant in this unit. Use of another refrigerant will damage the unit.

WARNING:

The information listed below must be followed during the installation, service, and operation of this unit. Unqualified individuals should not attempt to interpret these instructions or install this equipment. Failure to follow safety recommendations could result in possible damage to the equipment, serious personal injury or death.

- The installer must comply with all local codes and regulations which govern the installation of this type of equipment. Local codes and regulations take precedence over any recommendations contained in these instructions. Consult local building codes and the National Electrical Code (ANSI CI) for special installation requirements.
- All electrical wiring must be completed in accordance with local, state and national codes and regulations and with the National Electric Code (ANSI/NFPA 70) or in Canada the Canadian Electric Code Part 1 CSA C.22.1.
- This equipment contains liquid and gaseous refrigerant under high pressure. **DO NOT USE ANY PORTION OF THE CHARGE FOR PURGING OR LEAK TESTING.** Installation or servicing should only be performed by qualified trained personnel thoroughly familiar with this type equipment.
- Fully annealed, refrigerant grade copper tubing should be used when installing the system. Refrigerant suction line tubing should be fully insulated.
- Installation of equipment may require brazing operations. Installer must comply with safety codes and wear appropriate safety equipment (safety glasses, work gloves, fire extinguisher, etc.) when performing brazing operations.
- Follow all precautions in the literature, on tags, and on labels provided with the equipment. Read and thoroughly understand the instructions provided with the equipment prior to performing the installation and operational checkout of the equipment.
- Refrigerant and electrical line should be routed through suitably waterproofed openings to prevent water from leaking into the structure.

AIR CONDITIONER INSTALLATION

General Information

The S4BD series air conditioner is designed only for outdoor rooftop or ground level installations. This unit has been tested for capacity and efficiency in accordance with AHRI Standards and will provide many years of safe and dependable comfort, providing it is properly installed and maintained. Abuse, improper use, and/or improper maintenance can shorten the life of the appliance and create unsafe hazards.

To achieve optimum performance and minimize equipment failure, it is recommended that periodic maintenance be performed on this unit. The ability to properly perform maintenance on this equipment requires certain mechanical skills and tools.

Before You Install this Unit

- ✓ The cooling load of the area to be conditioned must be calculated and a system of the proper capacity selected. It is recommended that the area to be conditioned be completely insulated and vapor sealed.
- ✓ Check the electrical supply and verify the power supply is adequate for unit operation. The system must be wired and provided with circuit protection in accordance with local building codes. If there is any question concerning the power supply, contact the local power company.
- ✓ The indoor section (air handler, furnace, etc) should be installed before routing the refrigerant tubing. Refer to the indoor unit's installation instructions for installation details.
- ✓ All units are securely packed at the time of shipment and upon arrival should be carefully inspected for damage prior to installing the equipment at the job site. Verify coil fins are straight. If necessary, comb fins to remove flattened or bent fins. Claims for damage (apparent or concealed) should be filed immediately with the carrier.
- ✓ Please consult your dealer for maintenance information and availability of maintenance contracts. Please read all instructions before installing the unit.

Locating the Air Conditioner

- Survey the job site to determine the best location for mounting the outdoor unit.
- The outdoor unit should be installed no closer than 18 inches from the outside walls of the facility and in an area free from overhead obstructions to ensure unrestricted airflow through the outdoor unit.
- Sufficient clearance for unobstructed airflow through the outdoor coil must be maintained in order to achieve rated performance. See Figure 1 for minimum clearances to obstructions.
- Overhead obstructions (Figure 1), poorly ventilated areas, and areas subject to accumulation of debris should be avoided.
- Consideration should be given to availability of electric power, service access, noise, and shade.

Packaging Removal

NOTE: To prevent damage to the tubing connections, carefully remove the carton and user's manual from the equipment. Discard the shipping carton.

Ground Level

Ground level installations must be located according to local building codes or ordinances and these requirements:

- Clearances must be in accordance with those shown in Figure 1.
- A suitable mounting pad (Figure 1) must be provided and separate from the building foundation. The pad must be level and strong enough to support the weight of the unit. The slab height must be a minimum of 2" (5 cm) above grade and with adequate drainage.

Roof Mount

- The method of mounting should be designed so that it does not overload roof structures or transmit noise to the interior of the structure. The roof must be structurally capable of handling the weight of the unit.
- Full perimeter support is required under the unit. Support must be made of weather resistant materials and installed prior to unit installation.
- The support must be built to raise the unit 6" above the roof.

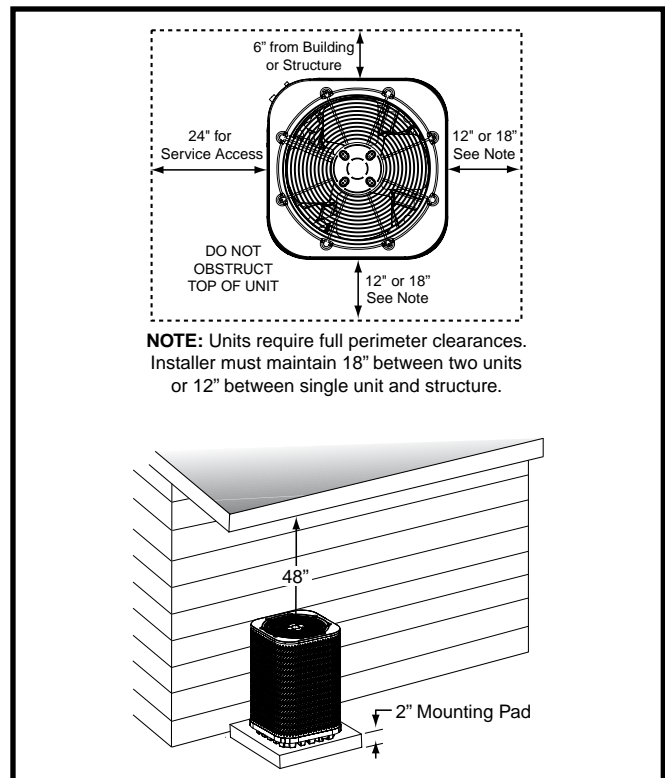

Figure 1. Clearance Requirements

⚠ CAUTION:

When servicing, cover or seal openings to minimize the exposure of the refrigerant system to air to prevent accumulation of moisture and other contaminants.

After outdoor and indoor unit placement has been determined, route refrigerant tubing between the equipment in accordance with sound installation practices.

- When connecting refrigerant linesets together, it is recommended that dry nitrogen be flowing through the joints during brazing to prevent internal oxidation and scaling.
- Refrigerant tubing should be routed in a manner that minimizes the length of tubing and the number of bends in the tubing. If precise forming of refrigerant lines is required, a copper tubing bender is recommended. Avoid sharp bends and contact of the refrigerant lines with metal surfaces.
- Refrigerant tubing should be supported in a manner that the tubing will not vibrate or abrade during system operation.
- Tubing should be kept clean of foreign debris during installation.
- Every effort should be made by the installer to ensure that the field installed refrigerant containing components of the system have been installed in accordance with these instructions and sound installation practices to insure reliable system operation and longevity.
- The maximum recommended interconnecting refrigerant line lengths is 75 ft. and the vertical elevation difference between the indoor and outdoor sections should not exceed 20 ft.
- A filter dryer is provided with the unit and must be installed in the liquid line of the system. If the installation replaces a system with a filter dryer already present in the liquid line, the filter dryer must be replaced with the one supplied with the unit. The filter dryer must be installed in strict accordance with the manufacturer's installation instructions.
- Optional equipment such as liquid line solenoid valves, low ambient, etc., should be installed in strict accordance with the manufacturer's installation instructions.

⚠ WARNING:

To avoid risk of electrical shock, personal injury, or death, disconnect all electrical power to the unit before performing any maintenance or service. The unit may have more than one electrical supply.

Label all wires prior to disconnection when servicing the unit. Wiring errors can cause improper and dangerous operation.

- All electrical connections must be in compliance with all applicable local codes and ordinances, and with the current revision of the National Electric Code (ANSI/NFPA 70).
- For Canadian installations the electrical connections and grounding shall comply with the current Canadian Electrical Code (CSA C22.1 and/or local codes).

Pre-Electrical Checklist

- ✓ Verify that the voltage, frequency, and phase of the supply source match the specifications on the unit rating plate.
- ✓ Verify that the service provided by the utility is sufficient to handle the additional load imposed by this equipment. Refer to the unit wiring label for proper voltage wiring.
- ✓ Verify factory wiring is in accordance with the unit wiring diagram (Figure 10 page 16). Inspect for loose connections.

Line Voltage

- A wiring diagram is located on the inside cover of the electrical box of the outdoor unit. The installer should become familiar with the wiring diagram before making any electrical connections to the outdoor unit.
- An electrical disconnect must be located within sight of and readily accessible to the unit. This switch shall be capable of electrically de-energizing the outdoor unit.
- Line voltage to the unit should be supplied from a dedicated branch circuit containing the correct fuse or circuit breaker for the unit. Incoming field wiring and minimum size of electrical conductors and circuit protection must be in compliance with information listed on the outdoor unit data label. Any other wiring methods must be acceptable to authority having jurisdiction.
- The outdoor unit requires both power and control circuit electrical connections. Refer to the wiring diagram / schematic for identification and location of outdoor unit field wiring interfaces (Figure 10 page 16). Make all electrical connections in accordance with all applicable codes and ordinances.
- Overcurrent protection must be provided at the branch circuit distribution panel and sized as shown on the unit rating label and according to applicable local codes. See the unit rating plate for minimum circuit ampacity and maximum overcurrent protection limits.

- Provide power supply for the unit in accordance with the unit wiring diagram, and the unit rating plate. Connect the line-voltage leads to the terminals on the contactor inside the control compartment.
- Use only copper wire for the line voltage power supply to this unit as listed in Table 1. Use proper code agency listed conduit and a conduit connector for connecting the supply wires to the unit. Use of rain tight conduit is recommended.
- 208/230 Volt units are shipped from the factory wired for 230 volt operation. For 208V operation, remove the lead from the transformer terminal marked 240V and connect it to the terminal marked 208V.
- Optional equipment requiring connection to the power or control circuits must be wired in strict accordance of the NEC (ANSI/NFPA 70), applicable local codes, and the instructions provided with the equipment.

COPPER WIRE SIZE — AWG (1% Voltage Drop)				
Supply Wire Length-Feet				Supply Circuit Ampacity
200	150	100	50	
6	8	10	14	15
4	6	8	12	20
4	6	8	10	25
4	4	6	10	30
3	4	6	8	35
3	4	6	8	40
2	3	4	6	45
2	3	4	6	50
2	3	4	6	55
1	2	3	4	60

Wire Size based on N.E.C. for 60° type copper conductors.

Table 1. Copper Wire Size

Grounding

WARNING:

The unit cabinet must have an uninterrupted or unbroken electrical ground to minimize personal injury if an electrical fault should occur. Do not use gas piping as an electrical ground!

This unit must be electrically grounded in accordance with local codes or, in the absence of local codes, with the National Electrical Code (ANSI/NFPA 70) or the CSA C22.1 Electrical Code. Use the grounding lug provided in the control box for grounding the unit.

Comfort Alert™ Diagnostics Module (Select Models Only)

The Comfort Alert™ Diagnostics Module (Figure 2) is a breakthrough innovation that troubleshoots heat pump and air conditioning system failures and accurately detects the cause of electrical and system related failures without any sensors. The module installs easily in the electrical box of the outdoor unit near the compressor contactor. By monitoring and analyzing data from the Copeland scroll compressor and the thermostat demand, the module can accurately detect the cause of electrical and system related failures without any sensors. A flashing LED indicator communicates the ALERT code and a diagnostic key is also imprinted on the side of the module to quickly direct the technician to the root cause of a problem.

NOTE: This module does not provide safety protection! The Comfort Alert™ Diagnostics Module is a monitoring device and cannot control or shut down other devices.

24 VAC Power Wiring

The Comfort Alert™ module requires a constant nominal 24 VAC power supply. The module cannot be powered by the **C** terminal on a defrost board or other control board without experiencing nuisance alerts. **NOTE:** The wiring to the module's **R** & **C** terminals must be routed directly from the indoor unit or thermostat.

If the constant 24 VAC (**R** wire) is not present in the outdoor unit, use one of the spare wires in the thermostat cable to bring power to the module. Connect the other end of the spare wire to **R** at the indoor unit or thermostat.

Thermostat Demand Wiring

The Comfort Alert™ module requires a thermostat demand signal to operate properly. The thermostat demand signal input (labeled **Y** on the module), should always be connected to the compressor contactor coil. **NOTE:** When the coil is energized, the demand signal input is 24 VAC. When the coil is not energized, the demand signal input should be less than 0.5 VAC.

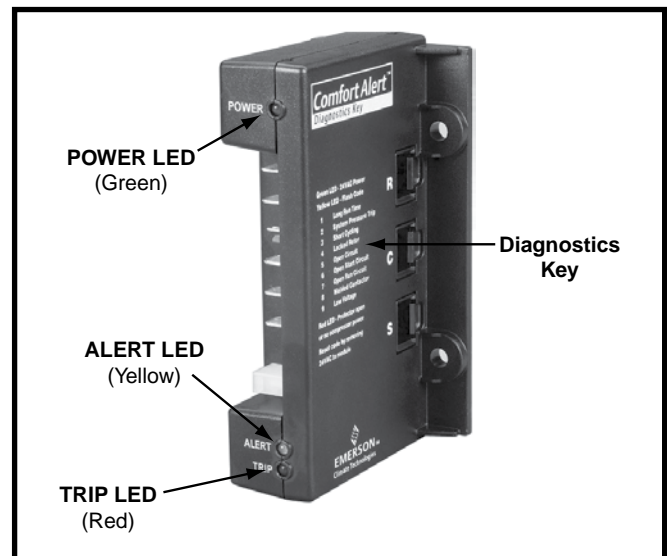

Figure 2. Comfort Alert™ Diagnostics Module

NOTES:

- Factory installed modules have different thermostat demand signal wiring. Always follow manufacturer wiring instructions when replacing the module.
- After the thermostat demand signal is connected, verify that 24 VAC across Y & C when demand is present.

Interpreting the Diagnostic LED's

When an abnormal system condition occurs, the Comfort Alert™ module displays the appropriate ALERT and/or TRIP LED will flash a number of times consecutively, pause and then repeat the process. To identify a Flash Code number, count the number of consecutive flashes.

Each time the module powers up, the last ALERT Flash Code that occurred prior to shut down is displayed for one minute. The module will continue to display the LED until the condition returns to normal or if 24 VAC power is removed from the module. See Table 10 (page 17) for flash code identification or Table 11 (page 18) for module wiring troubleshooting.

LED Description

- POWER LED (Green): indicates voltage is present at the power connection of the module.
- ALERT LED (Yellow): communicates an abnormal system condition through a unique flash code. **NOTE:** The ALERT LED will flash consecutively, pause and then repeat the process. The number of consecutive flashes, referred to as the Flash Code, correlates to a particular abnormal condition. Detailed descriptions of these ALERT Flash Codes are listed in Tables 10 & 11.
- TRIP LED (Red): indicates a demand signal is received from the thermostat, but current to the compressor is not detected by the module. The TRIP LED typically indicates if the compressor protector is open or the compressor has no power.

The scroll compressor's **R** (run), **C** (common), and **S** (start) wires are routed through the holes in the Comfort Alert™ module marked **R**, **C**, & **S**. **NOTE:** The common wire does not need to be routed through the module for it to operate.

Thermostat Connections

- Thermostat connections should be made in accordance with the instructions supplied with the thermostat and the indoor equipment.
- The outdoor unit is designed to operate from a 24 VAC Class II control circuit. The control circuit wiring must comply with the current provisions of the NEC (ANSI/NFPA 70) and with applicable local codes having jurisdiction.
- The low voltage wires must be properly connected to the units low voltage terminal block. Recommended wire gauge and wire lengths for typical thermostat connections are listed in Table 2.
- The thermostat should be mounted about 5 feet above the floor on an inside wall. DO NOT install the thermostat on an outside wall or any other location where its operation may be adversely affected by radiant heat from fireplaces, sunlight, or lighting fixtures, and convective heat from warm air registers or electrical

Thermostat Wire Gauge	Recommended T-Stat Wire Unit to T-Stat (Length in FT)	
	2-Wire (Heating)	5-Wire (Heating/Cooling)
24	55	25
22	90	45
20	140	70
18	225	110

Table 2. Thermostat Wire Gauge

appliances. Refer to the thermostat manufacturer's instruction sheet for detailed mounting and installation information.

AIR CONDITIONER MAINTENANCE

WARNING:

To prevent electrical shock, personal injury, or death, disconnect all electrical power to the unit before performing any maintenance or service. The unit may have more than one electrical supply.

Proper maintenance is important to achieve optimum performance from the air conditioner. The ability to properly perform maintenance on this equipment requires certain mechanical skills and tools. If you do not possess these skills, contact your dealer for maintenance. Consult your local dealer about the availability of maintenance contracts. Routine maintenance should include the following:

- Inspect and clean or replace air filters at the beginning of each heating and cooling season, or more frequently if required.
- Inspect the condensate drain and outdoor coil at the beginning of each cooling season. Remove any debris. Clean the outdoor coil and louvers as necessary using a mild detergent and water. Rinse thoroughly with water.
- Inspect the electrical connections for tightness at the beginning of each heating and cooling season. Service as necessary.

CAUTION:

The unit should never be operated without a filter in the return air system. Replace disposable filters with the same type and size.

- Do not attempt to add additional oil to motors unequipped with oil tubes. The compressor is hermetically sealed at the factory and does not require lubrication.

START UP & ADJUSTMENTS

Pre-Start Check List

- √ Verify the indoor unit is level and allows proper condensate drainage.
- √ Verify the outdoor coil and top of the unit are free from obstructions and debris, and all equipment access/control panels are in place.
- √ Verify air filters are cleaned and properly installed.
- √ Verify duct work is sealed to prevent air leakage.
- √ Verify line voltage power leads are securely connected and the unit is properly grounded.
- √ Verify low voltage wires are securely connected to the correct leads on the low voltage terminal strip.
- √ Verify power supply branch circuit overcurrent protection is sized properly.
- √ Verify the thermostat is wired correctly.

Start-Up Procedures

The thermostat's function mode should be set to OFF and the fan mode should be set to AUTO. Close all electrical disconnects to energize the system.

Air Circulation - Indoor Blower

1. Set the thermostat system mode on OFF and the fan mode to ON.
2. Verify the blower runs continuously. Check the air delivery at the supply registers and adjust register openings for balanced air distribution. If insufficient air is detected, examine ductwork for leaks or obstructions.
3. Set the thermostat fan mode to AUTO and verify the blower stops running.

System Cooling

1. Set the thermostat's system mode to COOL and the fan mode to AUTO. Gradually lower the thermostat temperature setpoint below room temperature and verify the outdoor unit and indoor blower energize.
2. Verify blower wheel is spinning in direction indicated by arrow. Feel the air being circulated by the indoor blower and verify that it is cooler than ambient temperature. Listen for any unusual noises. If unusual sounds occur, determine the source of the noise and correct as necessary.
3. Verify HI and LO refrigerant pressures.
4. Allow the system to operate for several minutes and then set the temperature selector above room temperature. Verify the fan and compressor cycle off with the thermostat. **NOTE:** The blower should also stop unless fan mode is set to the ON position.

System Heating (optional)

1. Set the thermostat's system mode to HEAT and the temperature mode above room temperature.
2. Verify the optional heating equipment (furnace or electric heat) and indoor blower energize. Feel the air being circulated by the indoor blower and verify that it is warmer than ambient temperature. Listen for any unusual noises. If unusual sounds occur, determine the source of the noise and correct as necessary.

Refrigerant Charging

WARNING:

S4BD Split System Air Conditioners are shipped charged with R410A refrigerant and ready for installation. If repairs make it necessary for evacuation and charging, it should only be attempted by qualified trained personnel thoroughly familiar with this equipment. Under no circumstances should the owner attempt to install and/or service this equipment. Failure to comply with this warning could result in property damage, personal injury, or death.

After refrigerant line connections are completed, it is required that you leak check and evacuate the indoor section and all line connections (using proper methods) before finalizing the full system refrigerant charge.

- Refrigerant charging charts are applicable only to matched assemblies of NORDYNE equipment and listed airflows for the indoor coil. Refer to Figures 3 - 9 (pages 8 - 11) and Tables 3 - 9 (pages 12 -15) for correct system charging.
- S4BD outdoor units with non-AHRI listed indoor coils are not recommended. Deviations from rated airflows or non-listed combinations may require modification to the expansion device and refrigerant charging procedures for proper and efficient system operation.
- The refrigerant charge can be checked and adjusted through the service ports provided external to the outdoor unit. Use only gage line sets which have a "Schrader" depression device present to actuate the valve.
- A high-pressure switch is factory-installed and located in the liquid line internal to the outdoor unit. The switch is designed to protect the system when very high pressures occur during abnormal conditions. Under normal conditions, the switch is closed. If the liquid pressure rises above 575 psig, then the switch will open and de-energize the outdoor unit. The switch will close again once the liquid pressure decreases to 460 psig. Please note that the switch interrupts the thermostat inputs to the unit. Thus, when the switch opens and then closes, there may be a 5 minute short cycling delay before the outdoor unit will energize.
- A low-pressure switch (Select Models) is factory-installed and located in the suction line internal to the outdoor unit. The switch is designed to protect the compressor from a loss of charge. Under normal conditions, the switch is closed. If the suction pressure falls below 5 psig, then the switch will open and de-energize the outdoor unit. The switch will close again once the suction pressure increases above 20 psig. Please note that the switch interrupts the thermostat inputs to the unit. When the switch opens and then closes, there will be a 5 minute short cycling delay before the outdoor unit will energize.

Charging the Unit in AC mode at outdoor temperatures above 55° F for optimized sub-cooling of 10° F - 12° F.

1. With the system operating at steady-state, measure the liquid refrigerant pressure (in psig) at the outdoor unit service valve.
2. Measure the liquid refrigerant temperature (in Fahrenheit) at the service valve.
3. Determine the required liquid refrigerant pressure from the appropriate charging chart (Figures 3 - 9).
 - If the pressure measured in Step 1 is greater than the required liquid refrigerant pressure determined in Step 3, then there is too much charge in the system. Remove refrigerant and repeat Steps 1 through 3 until the system is correctly charged.
 - If the pressure measured in Step 1 is less than the required liquid refrigerant pressure determined in Step 3, there is too little charge in the system. Add refrigerant and repeat Steps 1 through 3 until the system is correctly charged.

Application Notes for Using Charging Charts

- **This equipment's cooling system contains refrigerant under high pressure. Always use safe and environmentally sound methods when handling refrigerant handling or servicing the unit. Review the factory literature and safety warnings prior to servicing.**
- When repairing system leaks, always use a nitrogen (inert) gas to protect the refrigerant system and pressure check the repair before re-charging. Always replace the filter-dryers when performing any repair to the

- refrigeration system with one capable of acid removal. After completing the repairs, evacuate the system to 350 - 500 microns and weigh in the refrigerant to the amount specified on the unit rating label.
- Charging charts are valid for a variety of indoor, return air conditions and are most influenced by the outdoor ambient temperature, outdoor fan operation and the unit operating voltage. Before using these charts, make sure the unit is in a stable operating mode. As shown in the charging charts (Figures 3 - 9, pages 8 - 11), the ideal system sub-cooling can vary over the range of operation. Reference the charts to determine the ideal amount of sub-cooling for a given liquid pressure. Units charged to other values will not perform at the rated unit efficiency (EER) or rated Coefficient of Performance (COP) in heating mode.
- To inspect a systems operation using quality instruments, match the measured liquid temperature to the units chart. The measured liquid pressure reading should be within 3% of the charts value for most installations.
- For systems that are operating with more than a 5% deviation, inspect the unit for the proper voltage and phase balance and the refrigeration system for leaks.
- Units that are operating at less than 95% of the nominal voltage or with a 2% phase imbalance may see a more significant deviation than the amount stated above.
- **DO NOT** use the charts in systems that have a fan cycling under low-ambient control. Refer to the low-ambient kit instructions for more information. (If applicable)

S4BD REFRIGERANT CHARGING CHARTS

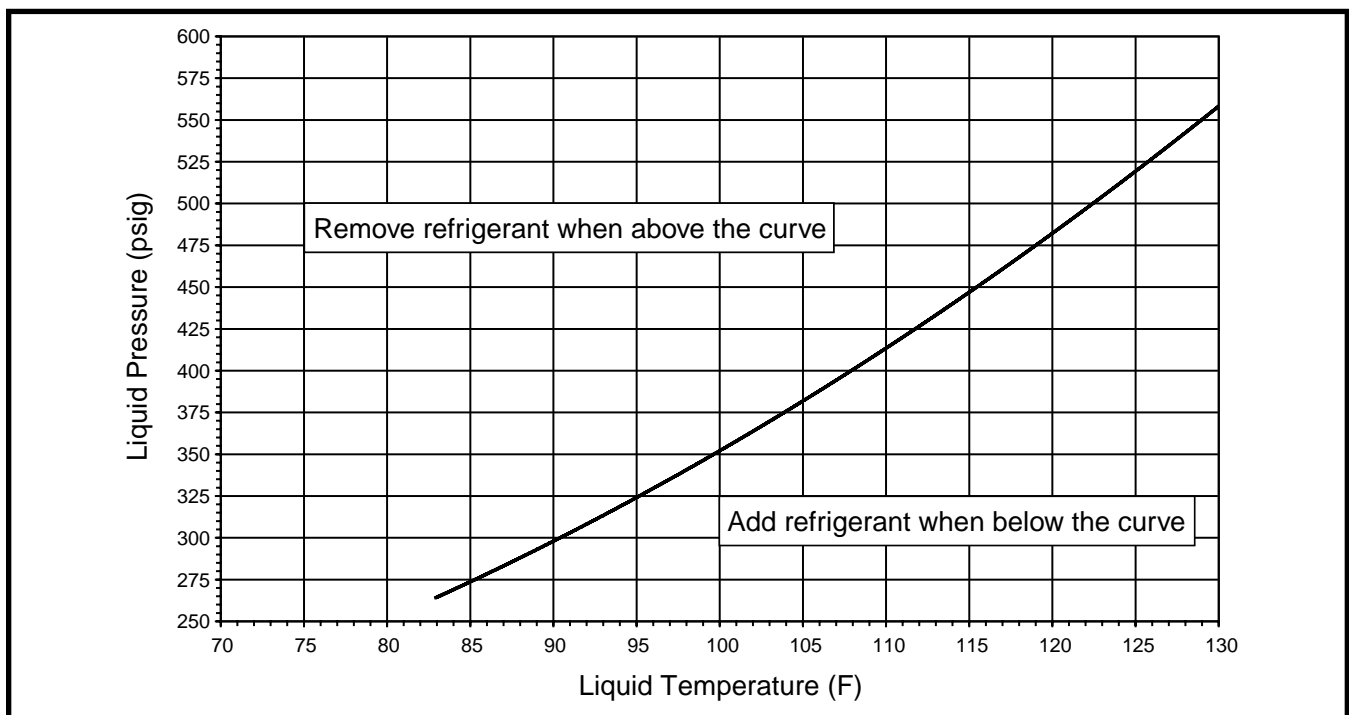

Figure 3. Charging Chart for S4BD-018 Series (1.5 Ton Units) - TXV Matches

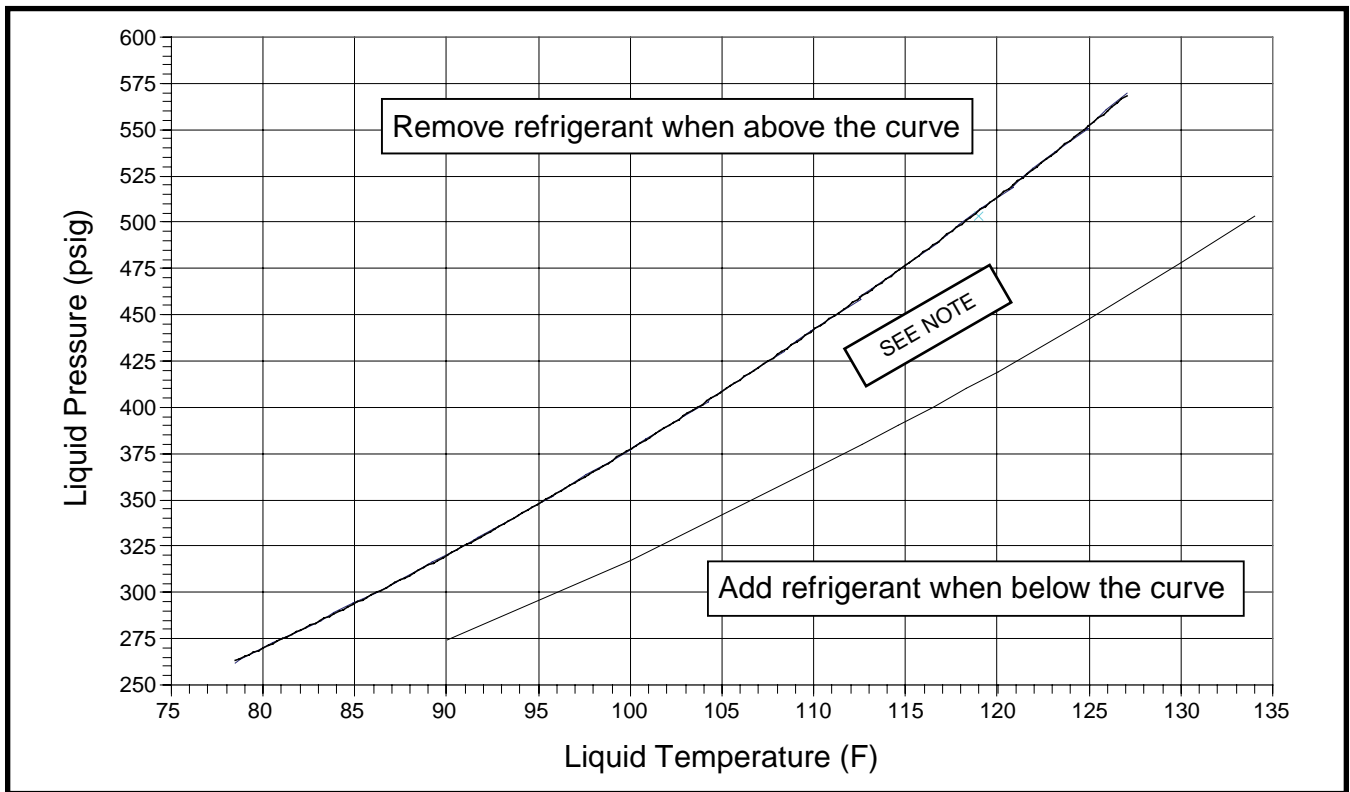

Figure 4. Charging Chart for S4BD-024 Series (2 Ton Units) - TXV Matches

NOTE: Do not add or remove refrigerant if pressure reading is between the curves.

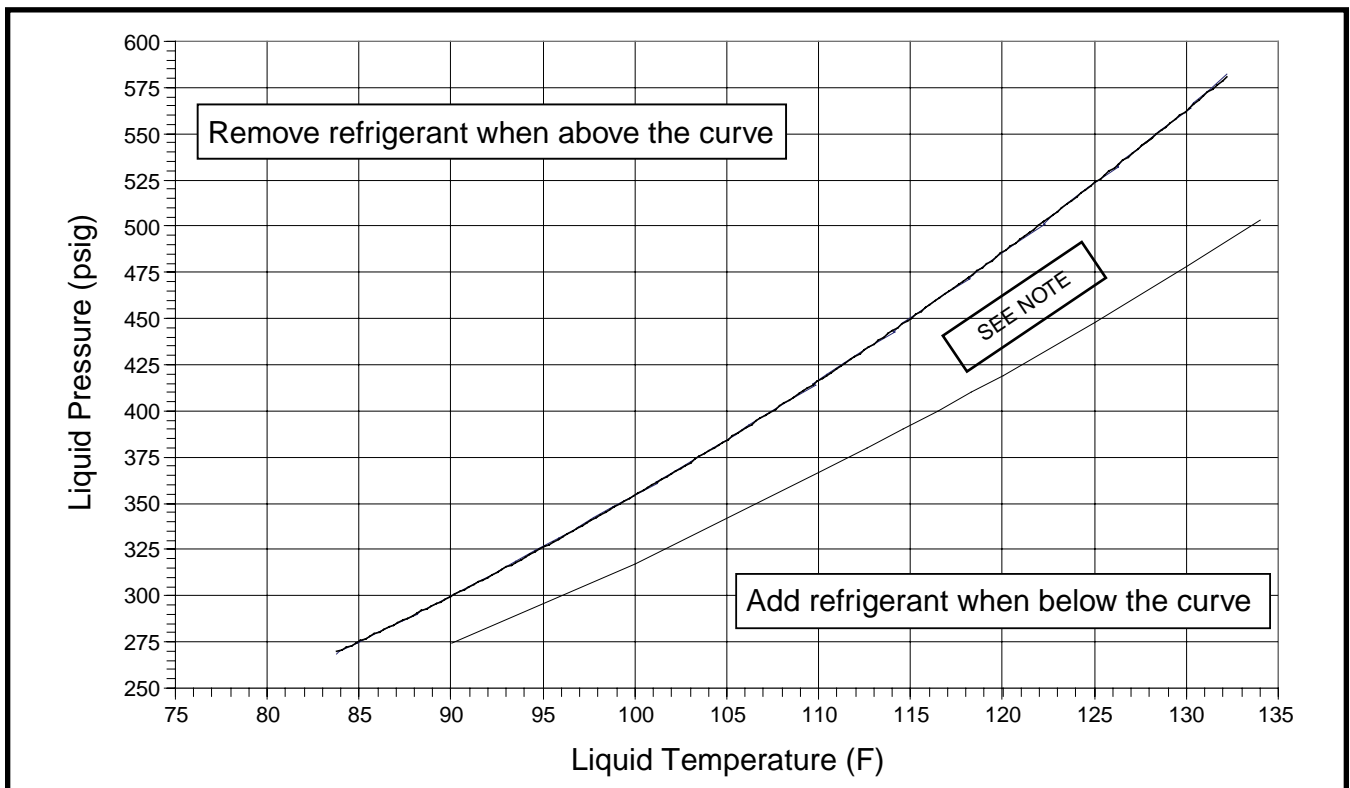

Figure 5. Charging Chart for S4BD-030 Series (2.5 Ton Units) - TXV Matches

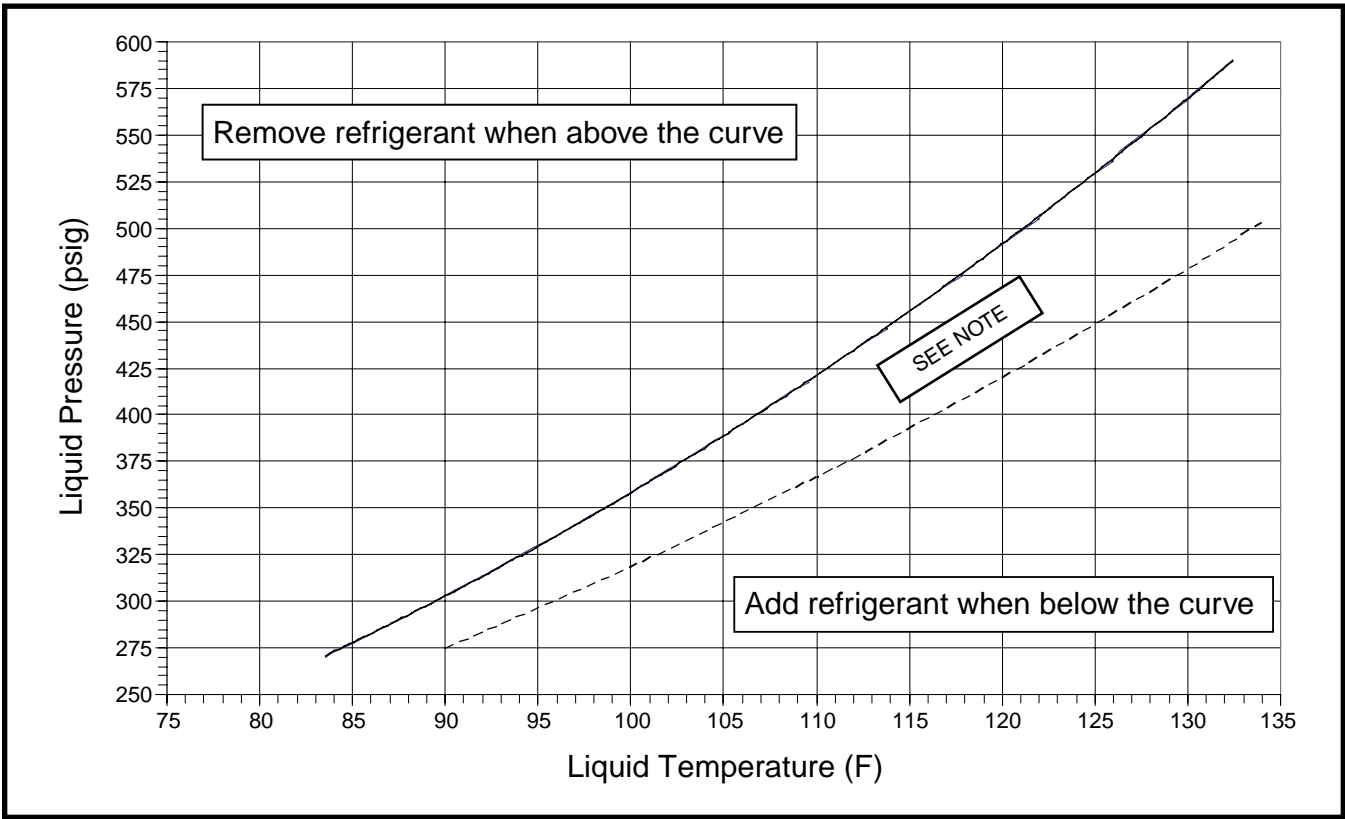

Figure 6. Charging Chart for S4BD-036 Series (3 Ton Units) - TXV Matches

NOTE: Do not add or remove refrigerant if pressure reading is between the curves.

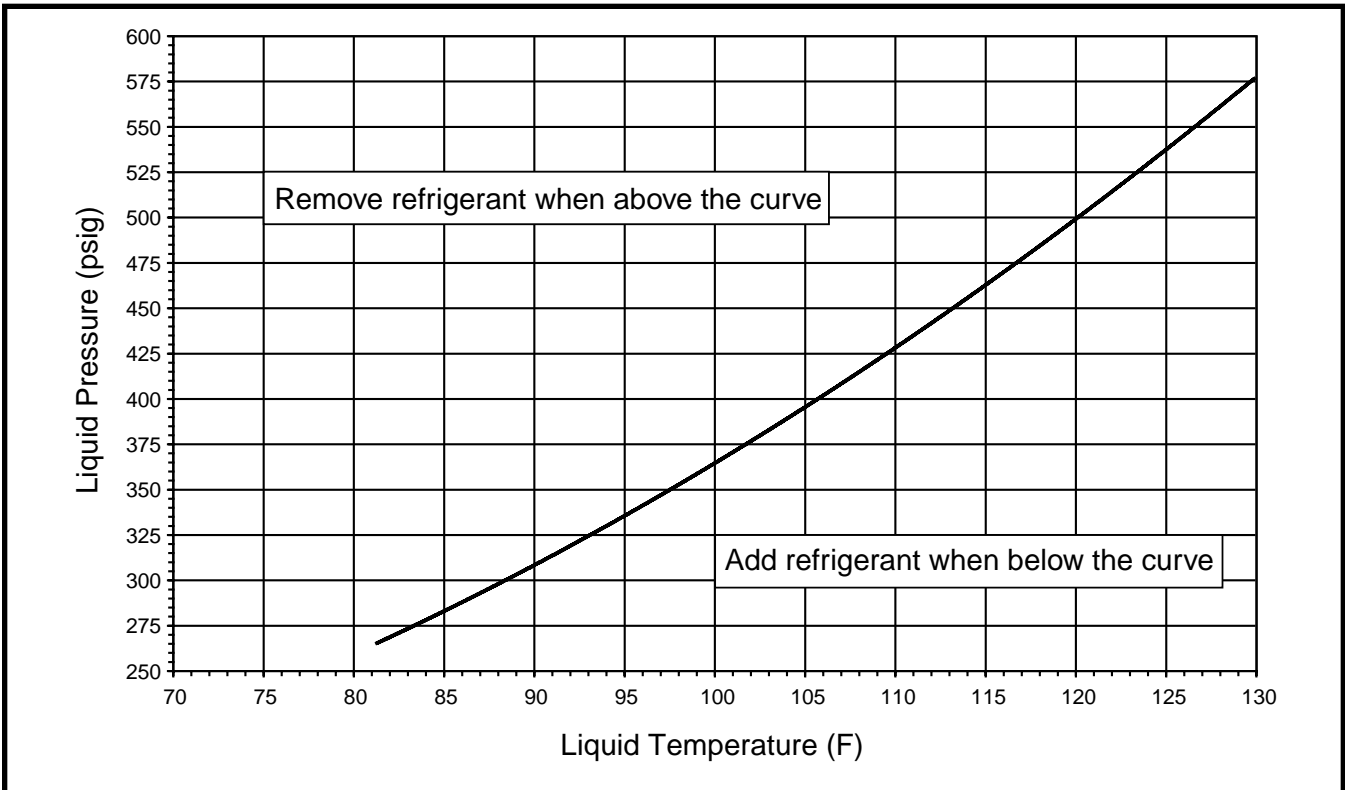

Figure 7. Charging Chart for S4BD-042 Series (3.5 Ton Units) - TXV Matches

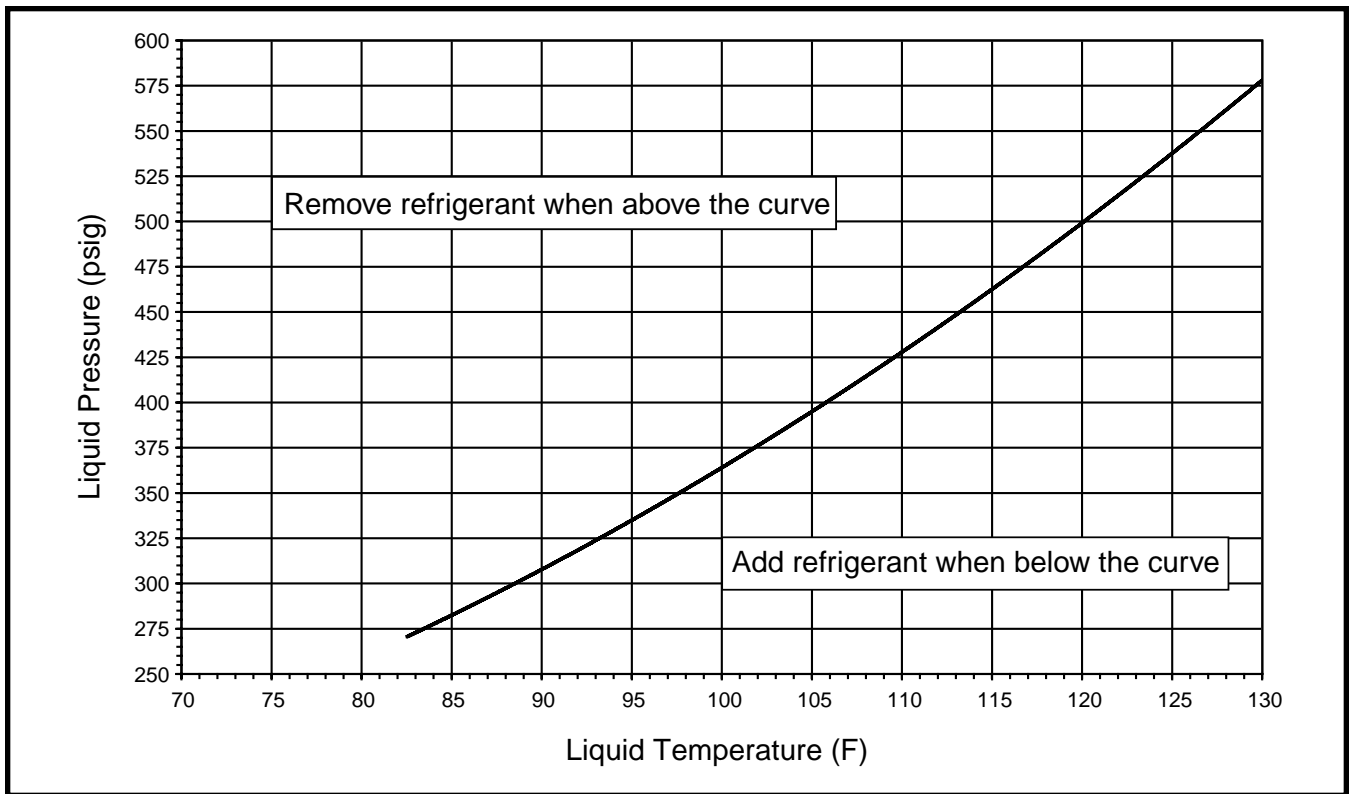

Figure 8. Charging Chart for S4BD-048 Series (4 Ton Units) - TXV Matches

NOTE: Do not add or remove refrigerant if pressure reading is between the curves.

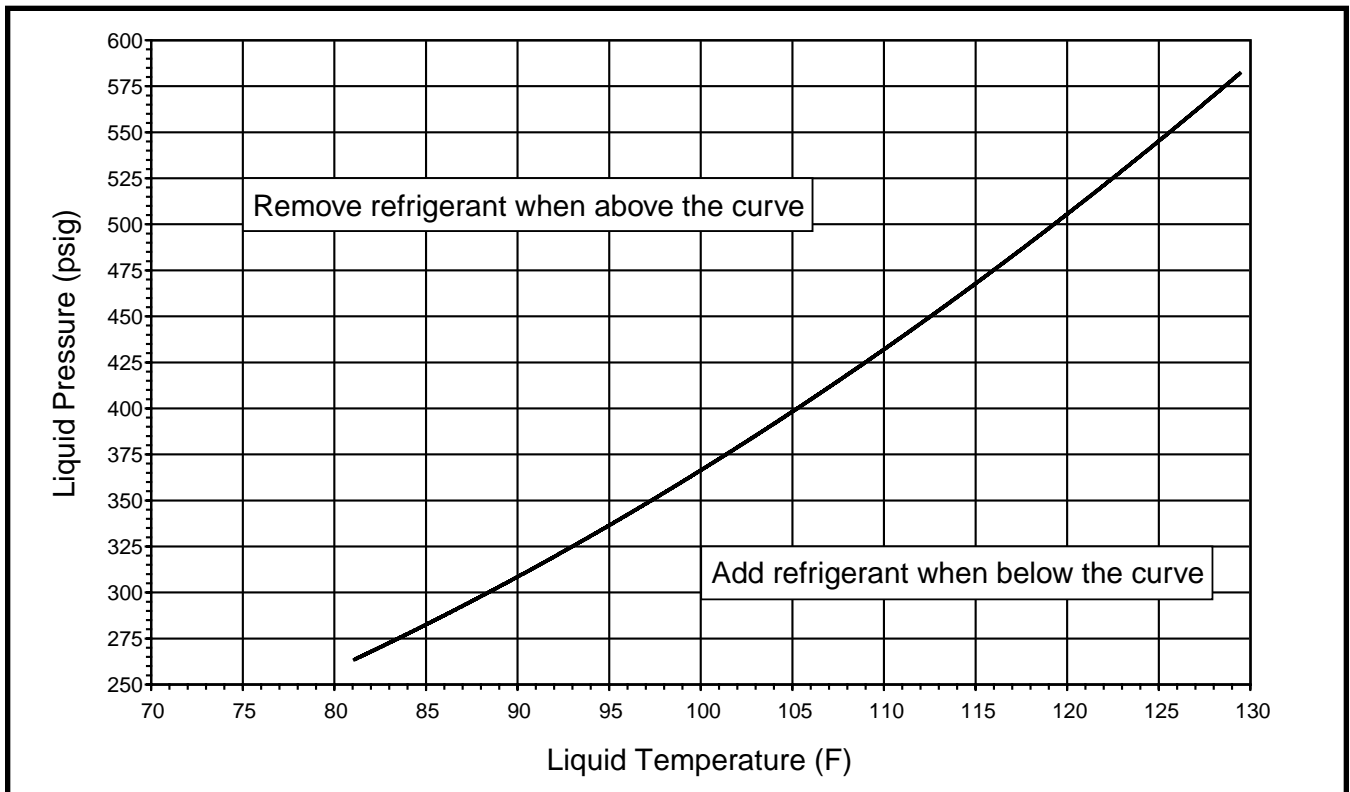

Figure 9. Charging Chart for S4BD-060 Series (5 Ton Units) - TXV Matches

S4BD REFRIGERANT CHARGING TABLES - COOLING ONLY

LEGEND

Shaded boxes indicate flooded conditions.

Rated design values. The suction pressure will be lower than design value if outdoor air flow, entering dry bulb, or entering wet bulb temperatures are lower than design.

NOTES:

1. All pressures are listed psig and all temperatures in °F
2. Discharge temperatures GREATER than charted values indicate an UNDERCHARGED system.
3. Discharge temperatures LESS than charted values indicate an OVERCHARGED system.

Suct. Press.	OUTDOOR TEMPERATURE (°F)															
	70		75		80		85		90		95		100		105	
	Liq. Press.	Dis. Temp.	Liq. Press.	Dis. Temp.	Liq. Press.	Dis. Temp.	Liq. Press.	Dis. Temp.	Liq. Press.	Dis. Temp.	Liq. Press.	Dis. Temp.	Liq. Press.	Dis. Temp.	Liq. Press.	Dis. Temp.
132	257	137														
134	258	140	280	140												
136	259	144	281	144	304	144										
138	260	147	282	147	305	147	327	147								
140	261	150	283	150	306	150	328	150	351	150						
142			284	153	307	153	329	153	352	153	374	154				
144					308	156	330	156	353	157	375	157	398	157		
146							331	159	354	159	376	160	399	160	421	160
148							333	162	355	162	377	163	400	163	422	163
150									356	165	379	166	401	166	423	166
152											380	169	402	169	424	169
154													403	172	426	172
156															427	175
158																

Table 3. Charging Table for S4BD-018 Series (1.5 Ton Units) - Orifice Matches

Suct. Press.	OUTDOOR TEMPERATURE (°F)															
	70		75		80		85		90		95		100		105	
	Liq. Press.	Dis. Temp.	Liq. Press.	Dis. Temp.	Liq. Press.	Dis. Temp.	Liq. Press.	Dis. Temp.	Liq. Press.	Dis. Temp.	Liq. Press.	Dis. Temp.	Liq. Press.	Dis. Temp.	Liq. Press.	Dis. Temp.
125	256	136														
127	257	139	280	139												
129	258	143	281	143	304	143										
131	259	146	282	146	305	146	328	146								
133	260	150	283	150	306	150	329	150	352	150						
135			284	153	307	153	330	153	353	153	376	153				
137					308	157	331	156	354	157	377	157	400	157		
139							333	160	355	160	378	160	401	160	424	160
141							334	163	357	163	379	163	402	164	425	164
143									358	166	381	166	403	167	426	167
145											382	169	405	170	428	170
147													406	173	429	173
149															431	176
151																

Table 4. Charging Table for S4BD-024 Series (2 Ton Units) - Orifice Matches

LEGEND

■ Shaded boxes indicate flooded conditions.

□ Rated design values. The suction pressure will be lower than design value if outdoor air flow, entering dry bulb, or entering wet bulb temperatures are lower than design.

NOTES:

1. All pressures are listed psig and all temperatures in °F
2. Discharge temperatures GREATER than charted values indicate an UNDERCHARGED system.
3. Discharge temperatures LESS than charted values indicate an OVERCHARGED system.

Suct. Press.	OUTDOOR TEMPERATURE (°F)															
	70		75		80		85		90		95		100		105	
	Liq. Press.	Dis. Temp.	Liq. Press.	Dis. Temp.	Liq. Press.	Dis. Temp.	Liq. Press.	Dis. Temp.	Liq. Press.	Dis. Temp.	Liq. Press.	Dis. Temp.	Liq. Press.	Dis. Temp.	Liq. Press.	Dis. Temp.
126	278	132														
128	280	135	303	137												
130	281	138	305	140	328	141										
132	283	141	306	143	330	144	354	145								
134	284	145	308	146	331	147	355	148	379	149						
136			309	149	333	150	357	151	380	152	404	154				
138					334	153	358	154	382	156	406	157	429	158		
140							360	157	384	159	407	160	431	161	454	162
142							361	161	385	162	409	163	432	164	456	165
144									387	164	411	166	434	167	457	168
146											412	168	436	170	460	171
148													438	172	462	173
150															464	176
152																

Table 5. Charging Table for S4BD-030 Series (2.5 Ton Units) - Orifice Matches

Suct. Press.	OUTDOOR TEMPERATURE (°F)															
	70		75		80		85		90		95		100		105	
	Liq. Press.	Dis. Temp.	Liq. Press.	Dis. Temp.	Liq. Press.	Dis. Temp.	Liq. Press.	Dis. Temp.	Liq. Press.	Dis. Temp.	Liq. Press.	Dis. Temp.	Liq. Press.	Dis. Temp.	Liq. Press.	Dis. Temp.
124	261	137														
126	263	141	287	140												
128	265	144	288	143	312	142										
130	266	147	290	146	313	146	337	145								
132	268	150	292	149	315	149	339	148	362	147						
134			293	153	317	152	340	152	364	151	387	150				
136					318	155	342	154	365	154	389	153	413	152		
138							344	158	367	157	390	157	414	156	438	155
140							345	161	369	160	392	160	416	159	439	158
142									370	163	394	163	417	162	441	162
144											396	166	419	165	442	165
146													421	168	444	168
148															446	171
150																

Table 6. Charging Table for S4BD-036 Series (3 Ton Units) - Orifice Matches

LEGEND

■ Shaded boxes indicate flooded conditions.

□ Rated design values. The suction pressure will be lower than design value if outdoor air flow, entering dry bulb, or entering wet bulb temperatures are lower than design.

NOTES:

1. All pressures are listed psig and all temperatures in °F
2. Discharge temperatures GREATER than charted values indicate an UNDERCHARGED system.
3. Discharge temperatures LESS than charted values indicate an OVERCHARGED system.

Suct. Press.	OUTDOOR TEMPERATURE (°F)															
	70		75		80		85		90		95		100		105	
	Liq. Press.	Dis. Temp.	Liq. Press.	Dis. Temp.	Liq. Press.	Dis. Temp.	Liq. Press.	Dis. Temp.	Liq. Press.	Dis. Temp.	Liq. Press.	Dis. Temp.	Liq. Press.	Dis. Temp.	Liq. Press.	Dis. Temp.
130	257	135														
132	259	138	282	138												
134	261	141	283	142	306	142										
136	262	144	285	145	307	145	330	146								
138	264	146	286	147	309	149	331	149	354	150						
140			288	150	310	151	333	152	355	153	378	153				
142					312	154	334	155	357	156	379	156	402	157		
144							336	158	358	159	381	160	404	160	426	161
146							337	161	359	162	382	163	405	163	428	164
148									361	165	383	166	406	166	429	167
150											385	169	407	169	430	170
152													408	172	431	173
154															432	176
156																

Table 7. Charging Table for S4BD-042 Series (3.5 Ton Units) - Orifice Matches

Suct. Press.	OUTDOOR TEMPERATURE (°F)															
	70		75		80		85		90		95		100		105	
	Liq. Press.	Dis. Temp.	Liq. Press.	Dis. Temp.	Liq. Press.	Dis. Temp.	Liq. Press.	Dis. Temp.	Liq. Press.	Dis. Temp.	Liq. Press.	Dis. Temp.	Liq. Press.	Dis. Temp.	Liq. Press.	Dis. Temp.
125	261	136														
127	262	140	285	140												
129	263	143	286	143	309	144										
131	265	146	287	147	310	147	333	148								
133	266	149	289	149	311	151	334	151	357	151						
135			290	152	312	153	335	154	358	155	381	155				
137					314	156	336	157	359	158	382	159	405	159		
139							338	160	360	161	383	162	406	163	429	163
141							339	163	361	164	384	165	407	166	430	166
143									363	167	385	168	408	169	431	170
145											387	171	409	172	432	173
147													410	175	433	176
149															434	179
151																

Table 8. Charging Table for S4BD-048 Series (4 Ton Units) - Orifice Matches

LEGEND

■ Shaded boxes indicate flooded conditions.

□ Rated design values. The suction pressure will be lower than design value if outdoor air flow, entering dry bulb, or entering wet bulb temperatures are lower than design.

NOTES:

1. All pressures are listed psig and all temperatures in °F
2. Discharge temperatures GREATER than charted values indicate an UNDERCHARGED system.
3. Discharge temperatures LESS than charted values indicate an OVERCHARGED system.

Suct. Press.	OUTDOOR TEMPERATURE (°F)															
	70		75		80		85		90		95		100		105	
	Liq. Press.	Dis. Temp.	Liq. Press.	Dis. Temp.	Liq. Press.	Dis. Temp.	Liq. Press.	Dis. Temp.	Liq. Press.	Dis. Temp.	Liq. Press.	Dis. Temp.	Liq. Press.	Dis. Temp.	Liq. Press.	Dis. Temp.
121	264	149														
123	265	153	289	153												
125	267	156	290	157	313	157										
127	268	159	291	160	314	161	338	161								
129	270	162	293	163	316	164	339	165	362	165						
131			294	166	317	167	340	168	363	169	387	169				
133					319	170	342	171	365	172	388	173	411	173		
135							343	174	366	175	389	176	412	177	435	178
137							345	177	368	178	391	179	414	180	437	181
139									369	181	392	182	415	183	438	184
141											394	185	417	186	440	187
143													418	189	441	190
145															442	193
147																

Table 9. Charging Table for S4BD-060 Series (5 Ton Units) - Orifice Matches

WIRING DIAGRAM

Split System Air Conditioner (Outdoor Section)

Single Phase

NOTES:

1. Disconnect all power before servicing.
2. For supply connections use copper conductors only.
3. Not suitable on systems that exceed 150 volts to ground.
4. For replacement wires use conductors suitable for 105 deg C.
5. For ampacities and overcurrent protection, see unit rating plate.
6. Connect to 24 vac/40ca/class 2 circuit. See furnace/airhandler installation instructions for control circuit and optional relay/transformer kits.
7. Anti-Short Cycle Timer (ASCT) may or may not be installed in the unit. If desired, ASCT is factory installed on select models only or may be field installed as shown using manufacturer's approved kit. If not present, connect Yellow and Black wires per Note 6.

1. Couper le courant avant de faire letretien.
2. Employez uniquement des conducteurs en cuivre.
3. Ne convient pas aux installations de plus de 150 volt a la terre.

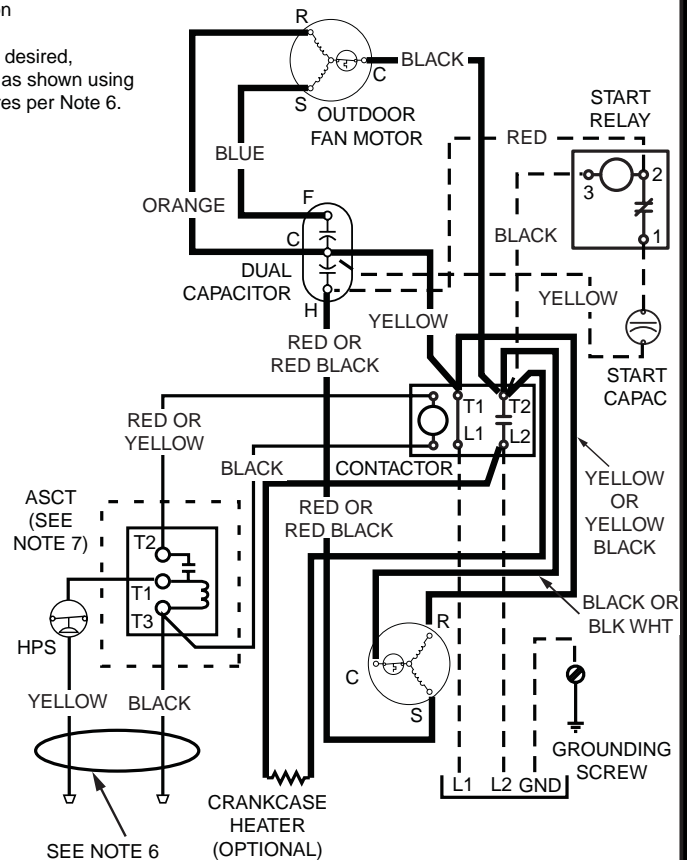
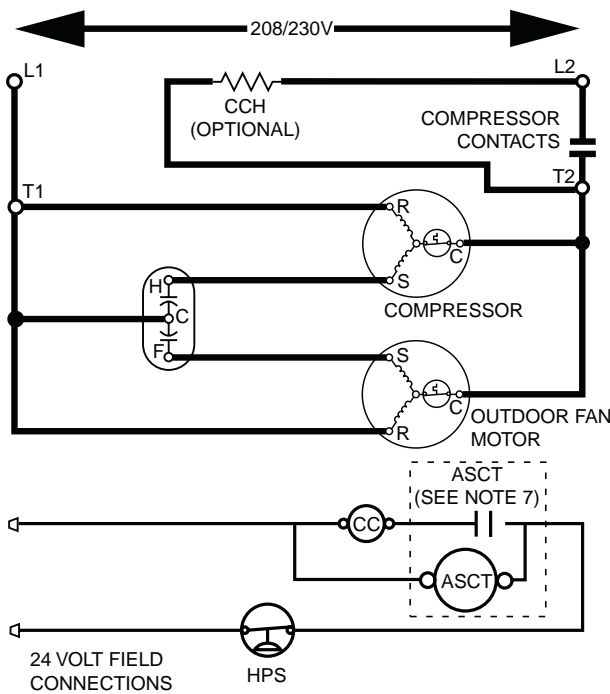

LEGEND:

CC - Contactor Coil
 CCH - Crankcase Heater
 HPS - High Pressure Switch

FIELD WIRING	---
LOW VOLTAGE	—
HIGH VOLTAGE	—



710388B
 (Replaces 710388A)

0109

Figure 10. Wiring Diagram for S4BD Single Phase Models (1.5, 2, 2.5, 3, 3.5, 4, & 5 Ton Units)

COMFORT ALERT TROUBLESHOOTING

Status LED	Status LED Description	Status LED Troubleshooting Information
POWER (Green LED)	Module has power	Supply voltage is present at module terminals
TRIP (Red LED)	Thermostat demand signal Y is present, but compressor is not running	<ul style="list-style-type: none"> • Compressor protector is open • Check for high head pressure • Check compressor supply voltage • Outdoor unit power disconnect is open • Compressor circuit breaker or fuse(s) is open • Broken wire or connector is not making contact • Low pressure switch open if present in system • Compressor contactor has failed open
ALERT Flash Code 1 (Yellow LED)	Long Run Time Compressor is running extremely long run cycles	<ul style="list-style-type: none"> • Low refrigerant charge • Evaporator blower is not running <ul style="list-style-type: none"> — Check blower relay coil and contacts — Check blower motor capacitor — Check blower motor for failure or blockage — Check evaporator blower wiring and connectors — Check indoor blower control board — Check thermostat wiring for open circuit • Evaporator coil is frozen <ul style="list-style-type: none"> — Check for low suction pressure — Check for excessively low thermostat setting — Check evaporator airflow (coil blockages or return airfilter) — Check ductwork or registers for blockage • Faulty metering device <ul style="list-style-type: none"> — Check TXV bulb installation (size, location and contact) — Check if TXV/fixed orifice is stuck closed or defective • Condenser coil is dirty • Liquid line restriction (filter drier blocked if present in system) • Thermostat is malfunctioning <ul style="list-style-type: none"> — Solenoid plug not connected — Y2 not wired at Comfort Alert — Check thermostat sub-base or wiring for short circuit — Check thermostat installation (location, level) • Comfort Alert failure
ALERT Flash Code 2 (Yellow LED)	System Pressure Trip	<ul style="list-style-type: none"> • High head pressure <ul style="list-style-type: none"> — Check high pressure switch if present in system — Check if system is overcharged with refrigerant — Check for non-condensable in system
	Discharge or suction	<ul style="list-style-type: none"> • Condenser coil poor air circulation (dirty, blocked, damaged)
	Pressure out of limits	<ul style="list-style-type: none"> • Condenser fan is not running <ul style="list-style-type: none"> — Check fan capacitor — Check fan wiring and connectors — Check fan motor for failure or blockage
	Compressor overloaded	<ul style="list-style-type: none"> • Return air duct has substantial leakage • If low pressure switch present in system, check Flash Code 1 information
ALERT Flash Code 3 (Yellow LED)	Short Cycling / Compressor is running only briefly	<ul style="list-style-type: none"> • Thermostat demand signal is intermittent • Low line voltage (contact utility if voltage at disconnect is low) • Excessive liquid refrigerant in compressor • Compressor bearings are seized
ALERT Flash Code 4 (Yellow LED)	Locked Rotor	<ul style="list-style-type: none"> • Run capacitor has failed • Low line voltage (contact utility if voltage at disconnect is low) • Check wiring connections • Excessive liquid refrigerant in compressor • Compressor bearings are seized • Measure compressor oil level
ALERT Flash Code 5 (Yellow LED)	Open Circuit	<ul style="list-style-type: none"> • Outdoor unit power disconnect is open • Compressor circuit breaker or fuse(s) is open • Compressor contactor has failed open <ul style="list-style-type: none"> — Check compressor contactor wiring and connectors — Check for compressor contactor failure (burned, pitted or open) — Check wiring and connectors between supply and compressor — Check for low pilot voltage at compressor contactor coil — High pressure switch is open and requires manual reset • Open circuit in compressor supply wiring or connections • Unusually long compressor protector reset time due to extreme ambient temperature • Compressor windings are damaged <ul style="list-style-type: none"> — Check compressor motor winding resistance

Table 10. LED Diagnostics

COMFORT ALERT TROUBLESHOOTING - CONTINUED

Status LED	Status LED Description	Status LED Troubleshooting Information
ALERT Flash Code 6 (Yellow LED)	Open Start Circuit Current only in run circuit	<ul style="list-style-type: none"> • Run capacitor has failed • Open circuit in compressor start wiring or connections <ul style="list-style-type: none"> — Check wiring and connectors between supply and the compressor S terminal • Compressor start winding is damaged <ul style="list-style-type: none"> — Check compressor motor winding resistance
ALERT Flash Code 7 (Yellow LED)	Open run circuit Current only in start circuit	<ul style="list-style-type: none"> • Open circuit in compressor run wiring or connections <ul style="list-style-type: none"> — Check wiring and connectors between supply and the compressor R terminal • Compressor run winding is damaged <ul style="list-style-type: none"> — Check compressor motor winding resistance
ALERT Flash Code 8 (Yellow LED)	Welded Contactor Compressor always runs	<ul style="list-style-type: none"> • Compressor contactor has failed closed • Thermostat demand signal not connected to module
ALERT Flash Code 9 (Yellow LED)	Low Voltage Control circuit < 17VAC	<ul style="list-style-type: none"> • Control circuit transformer is overloaded • Low line voltage (contact utility if voltage at disconnect is low) • Check wiring connections

* Flash code number corresponds to a number of LED flashes, followed by a pause and then repeated. Trip and alert LED's flashing at same time means control circuit voltage is too low for operation.

Table 10. LED Diagnostics - Continued

Miswired Module Indication	Recommended Troubleshooting Action
Green LED is not on, module does not power up	<ul style="list-style-type: none"> • Determine if both R & C module terminals are connected. • Verify voltage is present at module's R & C terminals.
Green LED intermittent, module powers up only when compressor runs	<ul style="list-style-type: none"> • Determine if R & Y terminals are wired in reverse. • Verify modules R & C terminals have a constant source.
Trip LED is on, but system and compressor check OK	<ul style="list-style-type: none"> • Verify Y terminal is connected to 24VAC at contactor coil. • Verify voltage at contactor coil falls below 0.5VAC when off. • Verify 24VAC is present across Y & C when thermostat demand signal is preset. If not, R & C are reversed wired.
TRIP LED & ALERT LED flashing together	<ul style="list-style-type: none"> • Verify R & C terminals are supplied with 19 - 28VAC.
ALERT Flash CODE 3 displayed incorrectly (Compressor short cycling)	<ul style="list-style-type: none"> • Verify Y terminal is connected to 24VAC at contactor coil. • Verify voltage at contactor coil falls below 0.5VAC when off.
ALERT Flash Code 5, 6, or 7 displayed incorrectly (Open Circuit, Open Start Circuit or Open Run Circuit)	<ul style="list-style-type: none"> • Verify the compressor run and start wires are routed through the module's current sensing holes. • Verify the Y terminal is connected to 24VAC at contactor coil. • Verify voltage at contactor coil falls below 0.5VAC when off.
ALERT Flash Code 6 (Open Start Circuit) displayed for Code 7 (Open Run Circuit) or vice-versa	<ul style="list-style-type: none"> • Verify the compressor run and start wires are routed through the correct module sensing holes.
ALERT Flash Code 8 displayed incorrectly (Welded Contactor)	<ul style="list-style-type: none"> • Determine if module's Y terminal is connected. • Verify Y terminal is connected to 24VAC at contactor coil. • Verify 24VAC is present across Y & C when thermostat demand signal is present. If not, R & C are reversed wired. • Verify voltage at contactor coil falls below 0.5VAC when off. • Review Thermostat Demand Wiring (page 10) for Y & C wiring.

Table 11. Module Wiring Troubleshooting

INSTALLATION / PERFORMANCE CHECK LIST

INSTALLATION ADDRESS:		
CITY _____	STATE _____	
UNIT MODEL # _____		
UNIT SERIAL # _____		
Unit Installed Minimum clearances per Figure 1 (page 3)?	YES	NO
INSTALLER NAME:		
CITY _____	STATE _____	

REFRIGERATION SYSTEM		
Was unit given 24 hr warm up period for crankcase heaters?	YES	NO
Stage-1 Liquid Pressure (high side) _____		
Stage-1 Suction Pressure (low side) _____		
Has the owner's information been reviewed with the customer?	YES	NO
Has the Literature Package been left with the unit?	YES	NO

ELECTRICAL SYSTEM		
Electrical connections tight?	YES	NO
Line voltage polarity correct?	YES	NO
Rated Voltage: _____ VOLTS		
L1-L2 Volts: _____ VOLTS		
L1-L3 Volts: _____ VOLTS		
L2-L3 Volts: _____ VOLTS		
Avg. Volts: _____ VOLTS		
Max. deviation of voltage from avg. volts: _____ VOLTS		
% Volt imbalance: _____ VOLTS		
Blower Motor HP: _____ Sheave Setting _____ # Turns		
Has the thermostat been calibrated?	YES	NO
Is the thermostat level?	YES	NO
Is the heat anticipator setting correct? (If Applicable)	YES	NO



REPLACEMENT PARTS

Replacement parts are available through all Nordyne distributors. Please have the complete model and serial number of the unit when ordering replacement parts.

Electrical:

- | | |
|-------------------|----------------------------|
| Capacitors | Temperature Limit Switches |
| Compressors | Thermostats |
| Contactors | Time Delay Relays |
| Pressure Switches | Transformers |
| Relays | |

Motors:

- Blower Motor
- Fan Motor

Components:

- | | |
|------------------|---------------|
| Blower Assembly | Fan Grille |
| Cabinet Panels | Filter/Driers |
| Expansion Valves | |



Specifications & illustrations subject to change without notice or incurring obligations.
O' Fallon, MO | Printed in U.S.A. (10/12)

709292B (Replaces 709292A)