

USER'S MANUAL

WINDOW/WALL-TYPE ROOM AIR CONDITIONER

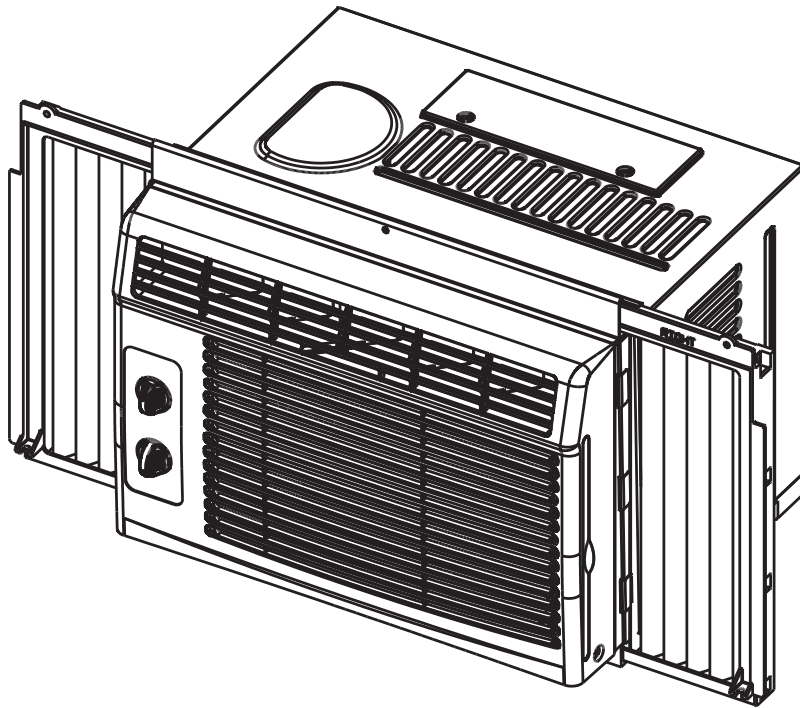

**Before using your air conditioner, please read
this manual carefully and keep it for future reference.**

CONTENTS

1. SAFETY PRECAUTIONS.....	2
2. IMPORTANT SAFETY INSTRUCTIONS	4
3. NORMAL SOUNDS	5
4. AIR CONDITIONER FEATURES	6
5. INSTALLATION INSTRUCTIONS.....	7
6. CARE AND CLEANING	11
7. TROUBLESHOOTING TIPS.....	12

Read This Manual

Inside you will find many helpful hints on how to use and maintain your air conditioner properly. Just a little preventive care on your part can save you a great deal of time and money over the life of your air conditioner. You'll find many answers to common problems in the chart of troubleshooting tips. If you review our chart of Troubleshooting Tips first, you may not need to call for service at all.



CAUTION

- Contact the authorised service technician for repair or maintenance of this unit.
- Contact the installer for installation of this unit.
- The air conditioner is not intended for use by young children or infirm persons without supervision.
- Young children should be supervised to ensure that they do not play with the air conditioner.
- If the power cord is to be replaced, replacement work shall be performed by authorised personnel only.
- Installation work must be performed in accordance with the national wiring standards by authorised personnel only.



NOTE: *All the illustrations in this manual are for explanation purpose only. Your air conditioner may be slightly different. The actual shape shall prevail.*

Safety Precautions

To prevent injury to the user or other people and property damage, the following instructions must be followed. Incorrect operation due to ignoring of instructions may cause harm or damage. The seriousness is classified by the following indications.

 WARNING	This symbol indicates the possibility of death or serious injury.
 CAUTION	This symbol indicates the possibility of injury or damage to property.

■ Meanings of symbols used in this manual are as shown below.

	Never do this.
	Always do this.

WARNING

⓪ Plug in power plug properly.

- Otherwise, it may cause electric shock or fire due to excess heat generation.

⓪ Do not operate or stop the unit by inserting or pulling out the power plug.

- It may cause electric shock or fire due to heat generation.

⓪ Do not damage or use an unspecified power cord.

- It may cause electric shock or fire.
- If the power cord is damaged, it must be replaced by the manufacturer or an authorised service centre or a similarly qualified person in order to avoid a hazard.

⓪ Do not modify power cord length or share the outlet with other appliances.

- It may cause electric shock or fire due to heat generation.

⓪ Do not operate with wet hands or in damp environment.

- It may cause electric shock.

⓪ Do not direct airflow at room occupants only.

- This could damage your health.

⓪ Always ensure effective earthing.

- Incorrect earthing may cause electric shock.

⓪ Do not allow water to run into electric parts.

- It may cause failure of machine or electric shock.

⓪ Always install circuit breaker and a dedicated power circuit.

- Incorrect installation may cause fire and electric shock.

⓪ Unplug the unit if strange sounds, smell, or smoke comes from it.

- It may cause fire and electric shock.

⓪ Do not use the socket if it is loose or damaged.

- It may cause fire and electric shock.

⓪ Do not open the unit during operation.

- It may cause electric shock.

⓪ Keep firearms away.

- It may cause fire.

⓪ Do not use the power cord close to heating appliances.

- It may cause fire and electric shock.

⓪ Do not use the power cord near flammable gas or combustibles, such as gasoline, benzene, thinner, etc.

- It may cause an explosion or fire.

⓪ Ventilate room before operating air conditioner if there is a gas leakage from another appliance.

- It may cause explosion, fire and, burns.

⓪ Do not disassemble or modify unit.

- It may cause failure and electric shock.

 **CAUTION**

⓪ When the air filter is to be removed, do not touch the metal parts of the unit.

- It may cause an injury.

⓪ Do not clean the air conditioner with water.

- Water may enter the unit and degrade the insulation. It may cause an electric shock.

⓪ Ventilate the room well when used together with a stove, etc.

- An oxygen shortage may occur.

⓪ When the unit is to be cleaned, switch off, and turn off the circuit breaker.

- Do not clean unit when power is on as it may cause fire and electric shock, it may cause an injury.

⓪ Do not put a pet or house plant where it will be exposed to direct air flow.

- This could injure the pet or plant.

⓪ Do not use for special purposes.

- Do not use this air conditioner to preserve precision devices, food, pets, plants, and art objects. It may cause deterioration of quality, etc.

⓪ Stop operation and close the window in storm or hurricane.

- Operation with windows opened may cause wetting of indoor and soaking of household furniture.

⓪ Hold the plug by the head of the power plug when taking it out.

- It may cause electric shock and damage.

⓪ Turn off the main power switch when not using the unit for a long time.

- It may cause failure of product or fire.

⓪ Do not place obstacles around air-inlets or inside of air-outlet.

- It may cause failure of appliance or accident.

⓪ Ensure that the installation bracket of the outdoor appliance is not damaged due to prolonged exposure.

- If bracket is damaged, there is concern of damage due to falling of unit.

⓪ Always insert the filters securely. Clean filter once every two weeks.

- Operation without filters may cause failure.

⓪ Do not use strong detergent such as wax or thinner but use a soft cloth.

- Appearance may be deteriorated due to change of product color or scratching of its surface.

⓪ Do not place heavy object on the power cord and ensure that the cord is not compressed.

- There is danger of fire or electric shock.

⓪ Do not drink water drained from air conditioner.

- It contains contaminants and could make you sick.

⓪ Use caution when unpacking and installing. Sharp edges could cause injury.

⓪ If water enters the unit, turn the unit off at the power outlet and switch off the circuit breaker. Isolate supply by taking the power-plug out and contact a qualified service technician.

IMPORTANT SAFETY INSTRUCTIONS

NOTE For some models, the power supply cord with this air conditioner contains a current detection device designed to reduce the risk of fire. Please refer to the section 'Operation of Current Device' for details. In the event that the power supply cord is damaged, it cannot be repaired-it must be replaced with a cord from the Product Manufacturer.

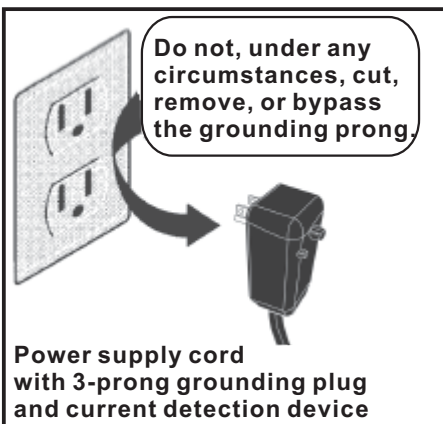

⚠ WARNING For your safety

- Do not store or use gasoline or other flammable vapors and liquids in the vicinity of this or any other appliance.
- Avoid fire hazard or electric shock. Do not use an extension cord or an adaptor plug. Do not remove any prong from the power cord.

⚠ WARNING Electrical Information

- Be sure the electrical service is adequate for the model you have chosen. This information can be found on the serial plate, which is located on the side of the cabinet and behind the grille.
 - Be sure the air conditioner is properly grounded. To minimize shock and fire hazards, proper grounding is important. The power cord is equipped with a three-prong grounding plug for protection against shock hazards.
 - Your air conditioner must be used in a properly grounded wall receptacle. If the wall receptacle you intend to use is not adequately grounded or protected by a time delay fuse or circuit breaker, have a qualified electrician install the proper receptacle.
 - Ensure the receptacle is accessible after the unit installation.
 - Do not run air conditioner without side protective cover in place. This could result in mechanical damage within the air conditioner.
- Do not use an extension cord or an adapter plug.**

Operation of Current Device

(Applicable to the unit adopts current detection device only)

The power supply cord contains a current device that senses damage to the power cord. To test your power supply cord do the following:

1. Plug in the Air Conditioner.
2. The power supply cord will have TWO buttons on the plug head. Press the TEST button, you will notice a click as the RESET button pops out.
3. Press the RESET button, again you will notice a click as the button engages.
4. The power supply cord is now supplying electricity to the unit. (On some products this is also indicated by a light on the plug head.)

NOTES:

- Do not use this device to turn the unit on or off.
- Always make sure the RESET button is pushed in for correct operation.
- The power supply must be replaced if it fails reset when either the TEST button is pushed, or it cannot be reset. A new one can be obtained from the product manufacturer.
- If power supply cord is damaged, it cannot be repaired. It MUST be replaced by one obtained from the product manufacturer.

NORMAL SOUNDS

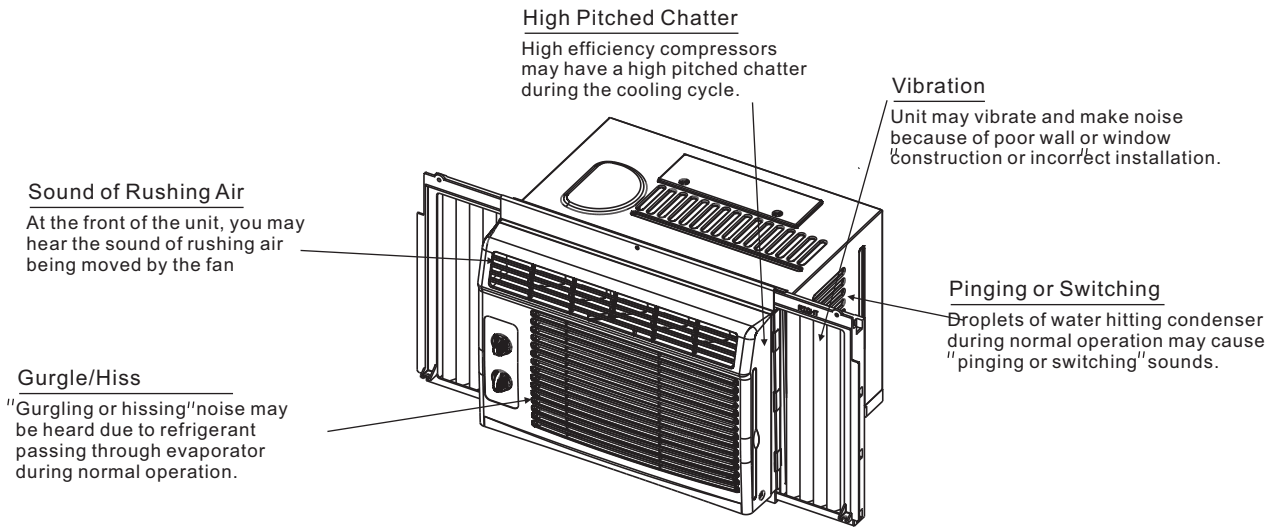

POINTS FOR USING AIR CONDITIONER

⚠ WARNING

To reduce the risk of fire, electric shock, or injury to persons, read the IMPORTANT SAFETY INSTRUCTIONS before operating this appliance.

NOTE: If the air conditioner is turned off, wait 3 minutes before restarting. This allows pressure inside the compressor and equalize. Failure to follow these instructions may be harmful to your unit.

To begin operating the air conditioner, follow these steps:

1. Set the thermostat to the highest number (coldest or cooler setting).
2. Set the selector control to the highest COOL setting.
3. Adjust the louver for comfortable air flow (see Air Directional Louvers).
4. Once the room has cooled, adjust the thermostat to the setting you find most comfortable.
5. Make sure that the air flow inside and outside are not obstructed by anything.
6. This air conditioner is designed to be operated under conditions as follows:

Cooling operation	Outdoor temp:	18-43°C(T ₁ Environment)	21-52°C(T ₃ Environment)
	Indoor temp:	17-32 °C(T ₁ Environment)	17-32°C(T ₃ Environment)
Heating operation	Outdoor temp:	-5-24°C(T ₁ Environment)	-7-24°C(T ₃ Environment)
	Indoor temp:	0 -27 °C(T ₁ Environment)	0-30°C(T ₃ Environment)

Note: Performance may be reduced outside of these operating temperatures.

AIR CONDITIONER FEATURES

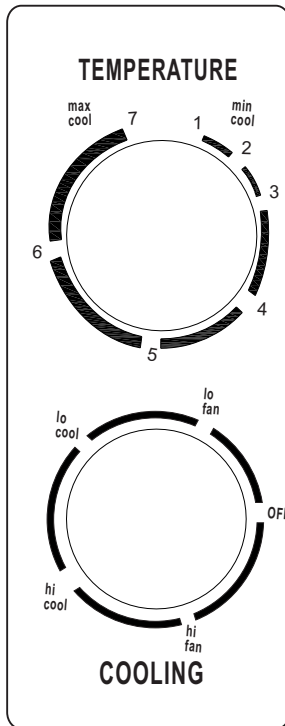

The controls featured in this manual are representative of many available models. Your model may offer slightly different features.

Cool Mode

The desired cool setting is selected by rotating the knob to the right to the appropriate location.

"HI COOL" has maximum cooling effect and airflow.

"LO COOL" has minimum cooling effect and airflow.

Fan Mode

Rotate the knob to the left to select your choice of fan speeds for air circulation.

NOTE: When selecting a fan speed, the compressor will not run.

Thermostat

The thermostat is used to set the desired room temperature when the unit is being operated in the "COOL MODE."

To set the desired room temperature, rotate the thermostat switch to the desired setting. After the set temperature is achieved the thermostat will automatically start and stop the compressor in order to maintain the desired set temperature.

Rotate the thermostat selector clockwise for higher cool settings. Higher cool settings will provide lower room temperature. Rotate the thermostat selector counter clockwise for lower cool settings. Lower cool settings will provide higher room temperature.



Please always wait 3 minutes when turning unit off then on again, and when changing from cool to fan and back to cool. This prevents compressor from overheating & possible circuit breaker tripping.

Air Directional Louvers

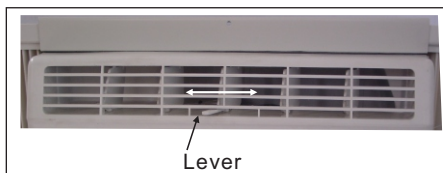

Air Direction

The louvers will allow you to direct the air flow Left or Right throughout the room as needed.

Move the Levers from side to side until the desired Left/Right direction is obtained.

INSTALLATION INSTRUCTIONS

Your air conditioner is designed to install in standard double hung windows with opening widths of 23 to 36 inches (584mm to 914mm) (See Fig.1).

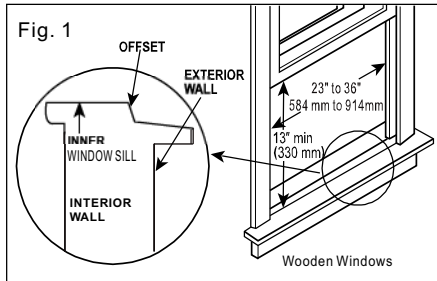

Lower sash must open sufficiently to allow a clear vertical opening of 13 inches (330mm). Side louvers and the rear of the AC must have clear air space to allow enough airflow through the condenser, for heat removal. The rear of the unit must be outdoors, not inside a building or garage.

NOTE: Save **Carton** and these **Installation Instructions** for future reference. The carton is the best way to store unit during winter, or when not in use.

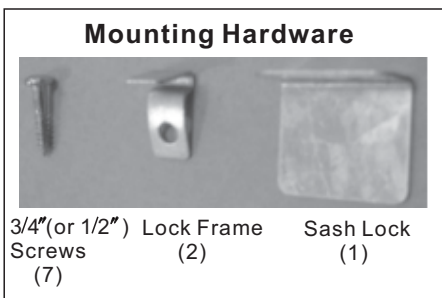

TOOLS NEEDED:

Phillips Screw Driver
Drill (If pilot holes are needed)

CAUTION: When handling unit, be careful to avoid cuts from sharp metal edges and aluminum fins on front and rear coils.



Before installing unit, the top rail must be assembled on the unit.

Tool Needed: Phillips Screwdriver

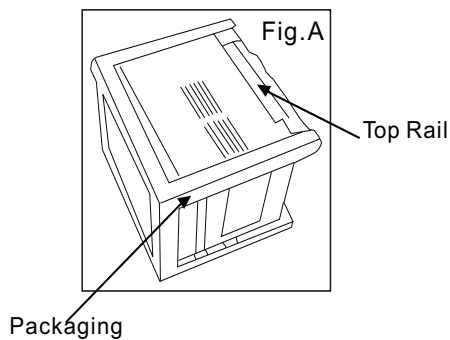

A: Remove the air conditioner from the carton and place on a flat surface.

B: Remove top rail from the rear of the packaging material as shown in Fig. A.

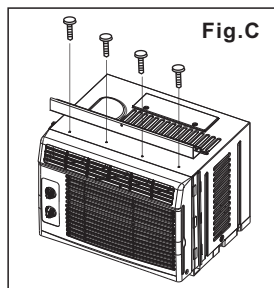
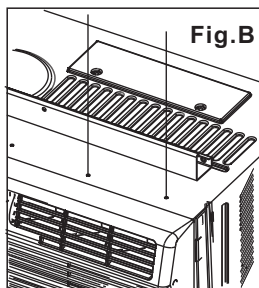

C: Align the hole in the top rail with those in the top of the unit as shown in Fig. B

D: Secure the top rail to the unit with the 3/8\"

NOTE: For safety reasons, all four(4) screws **MUST** be securely fastened.

HOW TO INSTALL

NOTE: Top rail and Sliding Panels at each side are offset to provide the proper pitch to the rear of (5/16"). This is necessary for proper condensed water utilization and drainage. If you are not using the Side Panels for any reason, this pitch to the rear must be maintained.

1 Place unit on floor, a bench or a table. There is a Left and Right Window Filler Panel- be sure to use the proper panel for each side. When installed the flange for securing the panel in place to the window sill will be facing into the room.

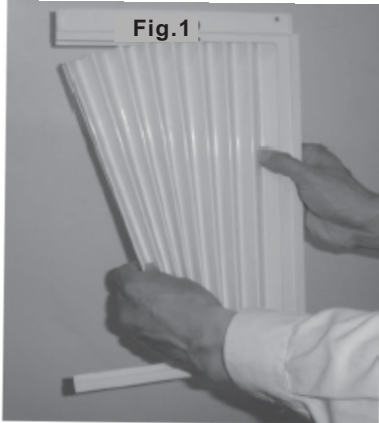

A. Hold the Accordion Panel in one hand and gently pull back the center to free the open end. See Fig. 1.



B. Slide the free end ("I" section) of the panel into the cabinet as shown in Fig. 2A, 2B & 3. Slide the panel down. Be sure to leave enough space to slip the top and bottom of the frame into the rails on the cabinet.

C. Once the panel has been installed on the side of the cabinet, make sure it sits securely inside the frame channel by making slight adjustments. Slide the top and bottom ends of the frame into the top and bottom rails of the cabinet. Fig. 4.

D. Slide the panel all the way in and repeat on the other side.



NOTE: If storm window blocks AC, see Fig. 11.

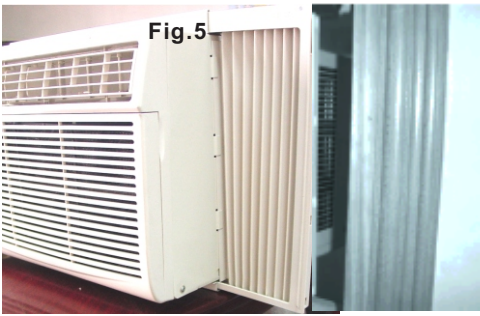

2 Keep a firm grip on the air conditioner, carefully place the unit into the window opening so the bottom of the air conditioner frame is against the window sill (Fig.5). Carefully close the window behind the top rail of the unit.



3 Extend the side panels out against the window frame (Fig.6).

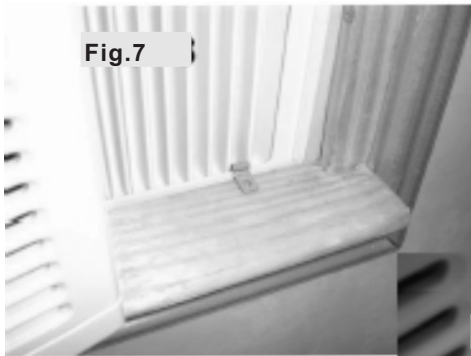

4 Place the frame lock between the frame extensions and the window sill as shown(Fig.7). Drive 3 / 4''(19mm) or 1 / 2''(13mm) locking screws through the frame lock and into the sill (Fig.8).
NOTE: To prevent window sill from splitting, drill 1 / 8''(3mm) pilot holes before driving screws.

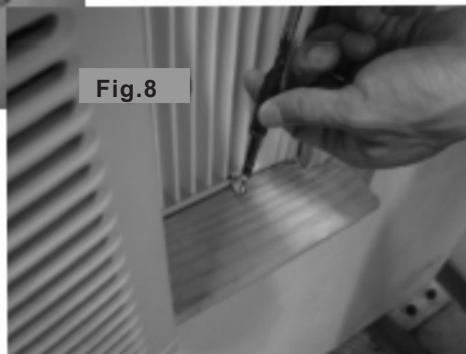

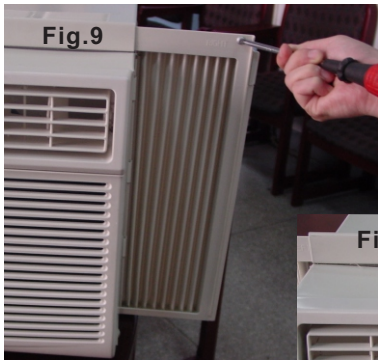

5 Drive 1 / 2''(13mm) locking screws through frame holes into window sash (Fig.9/10)



6 To secure lower sash in place, attach right angle sash lock with 3 / 4''(19mm) or 1 / 2''(13mm)screw as shown(Fig.11).

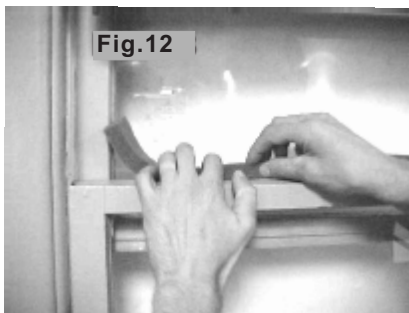

7 Cut foam seal and insert in the space between the upper and lower sashes (Fig.12).

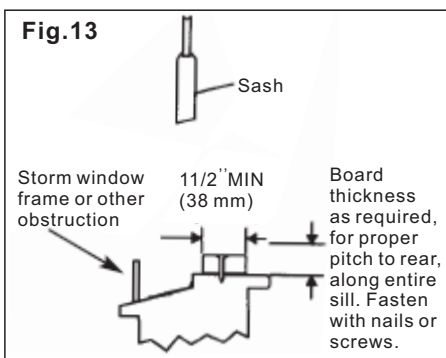

If AC is Blocked by Storm Window

Add wood as shown in Fig.13, or remove storm window before air conditioner is installed.

If Storm Window Frame must remain, be sure the drain holes or slots are not caulked or painted shut. Accumulated Rain Water or Condensation must be allowed to drain out.

Removing AC From Window

- ◆ Turn AC off, and disconnect power cord.
- ◆ Remove sash seal from between windows, and unscrew safety lock.
- ◆ Remove screws installed through frame and frame lock.
- ◆ Close (slide) side panels into frame.
- ◆ Keeping a firm grip on air conditioner, raise sash and carefully "rock" air conditioner backward to drain any condensate water in base of unit. Be carefully not to spill any remaining water while lifting unit from window. Store parts WITH air conditioner.

CARE AND CLEANING

CAUTION

Clean your air conditioner occasionally to keep it looking new. **Be sure to unplug the unit before cleaning to prevent shock or fire hazards.**

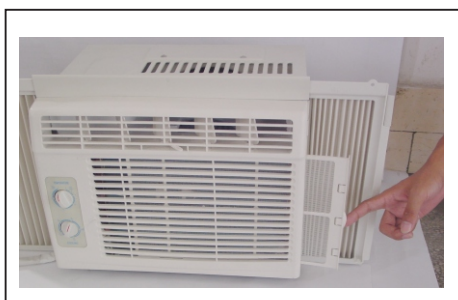

Air Filter Cleaning

The air filter should be checked at least once a month to see if cleaning is necessary. Trapped particles in the filter can build up and cause an accumulation of frost on the cooling coils.

- Remove the filter by sliding out from the right-hand side.
- Wash the filter using liquid dishwashing detergent and warm water. Rinse filter thoroughly. Gently shake excess water from the filter. Be sure the filter is thoroughly dry before replacing.
- Or, instead of washing you may vacuum the filter clean.

Note: Never use hot water over 40C(104F) to clean the air filter. Never attempt to operate the unit without the air filter.

Cabinet Cleaning

- Be sure to unplug the air conditioner to prevent shock or fire hazard. The cabinet and front may be dusted with an oil-free cloth or washed with a cloth dampened in a solution of warm water and mild liquid dishwashing detergent. Rinse thoroughly and wipe dry.
- Never use harsh cleaners, wax or polish on the cabinet front.
- Be sure to wring excess water from the cloth before wiping around the controls. Excess water in or around the controls may cause damage to the air conditioner.
- Plug in air conditioner.

Winter Storage

- If you plan to store the air conditioner during the winter, remove it carefully from the window according to the installation instructions. Cover it with plastic or return it to the original carton.

TROUBLESHOOTING TIPS

Before calling for service, review this list. It may save you time and expense. This list includes common occurrences that are not the result of defective workman-ship or materials in this appliance.

Problem	Solution
Air conditioner does not start	<i>Wall plug disconnected. Push plug firmly into wall outlet.</i>
	<i>House fuse blown or circuit breaker tripped. Replace fuse with time delay type or reset circuit breaker.</i>
	<i>Selector Control in OFF position. Turn selector to the desired FAN or COOL setting.</i>
	<i>Unit turned off by moving thermostat to a higher number and then immediately turning back to a colder number. Wait approximately 3 minutes. Listen for compressor to start.</i>
	<i>Unit turned off and then on too quickly. Turn unit off and wait 3 minutes before restarting.</i>
	<i>Thermostat set too low. Adjust thermostat to higher number for cooling.</i>
Air from unit does not feel cold enough	<i>Turn selector to a higher COOL position.</i>
	<i>Thermostat set too warm. Set thermostat to colder temperature.</i>
	<i>Room temperature below 17°C(62°F). Cooling may not occur until room temperature rises above 17°C(62°F).</i>
	<i>Temperature sensing tube touching cold coil, located behind air filter. Straighten tube away from coil.</i>
Air conditioner cooling, but room is too warm- ice forming on cooling coil behind decorative front.	<i>Outdoor temperature below 18°C(64°F). To defrost the coil, set selector to FAN position. Then, set thermostat to warmer position.</i>
	<i>Air filter may be dirty. Clean filter. Refer to Care and Cleaning section. To defrost, set selector to FAN.</i>
	<i>Thermostat set too cold for night-time cooling. To defrost the coil, set selector to a FAN position. Then, set thermostat to a warmer position.</i>
Air conditioner cooling, but room is too warm- NO ice forming on cooling coil behind decorative front.	<i>Dirty air filter- air restricted. Clean air filter. Refer to Care and Cleaning section.</i>
	<i>Thermostat set too warm. Turn thermostat clockwise to a colder setting.</i>
	<i>Air directional louvers positioned improperly. Position louvers for better air distribution.</i>
	<i>Front of units is blocked by drapes, blinds, furniture, etc. - restricts air distribution. Clear blockage .</i>
	<i>Doors, windows, registers, etc. Open- cold air escapes. Close doors, windows, registers.</i>
	<i>Unit recently turned on in hot room. Allow additional time to remove " Stored heat" from walls, ceiling, floor and furniture.</i>
Air conditioner turns on and off rapidly	<i>Dirty air filter- air restricted. Clean air filter.</i>
	<i>Outside temperature extremely hot. Set to high cool to bring air past cooling coils more frequently.</i>
Noise when unit is cooling	<i>Air movement sound. This is normal . If too loud, turn selector to lower FAN setting.</i>
	<i>Sound of fan hitting water-moisture removal system. This is normal when humidity is high. Close doors, windows and registers.</i>
	<i>Window vibration - poor installation. Refer to installation instructions or check with installer.</i>
Water dripping INSIDE when unit is cooling.	<i>Improper installation. Tilt air conditioner slightly to the outside to allow water drainage. Refer to installation instructions - check with installer.</i>
Water dripping OUTSIDE when unit is cooling.	<i>Unit removing large quantity of moisture from humid room. This is normal during excessively humid days.</i>

CS358-UA
202000192256