

LUX[®] KONO

Installation Settings Guide

In this guide we will describe the advanced installation settings that you can access from KONO Smart's main menu. We recommend that an HVAC service professional uses these settings to fine-tune your thermostat's performance for your home.

You can access the installation settings by going to the main menu and selecting the gear icon. You will see "IS" on the screen and will be prompted to select "yes" or "no". Select "yes" to access the installation settings.

There are three ways to exit the settings:

1. Continue through the remaining settings until you pass setting 99.
2. Press and hold the knob for 3 seconds after you confirm any changes to your settings.
3. Wait 60 seconds after you confirm any changes to your settings.



System Type & Configuration

You will first see your current system type and configuration – confirm by pressing the knob and then you will begin navigating through the available settings.

HVAC system type
F = Furnace
HP = Heat Pump

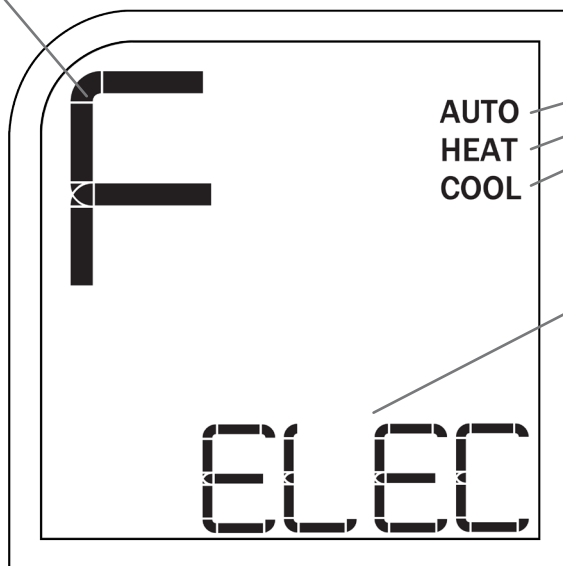

Available System Modes

HVAC system subtype

Furnace systems:

ELEC: Electric fan. Thermostat calls fan to run with heat

GAS: Gas fan. Thermostat does not call fan to run with heat

BOIL: Boiler. No fan connected to heating system

Heat Pump

o: Changeover valve = o
b: Changeover valve = B

-01 Temperature Format

Use this setting to select your preferred temperature format.

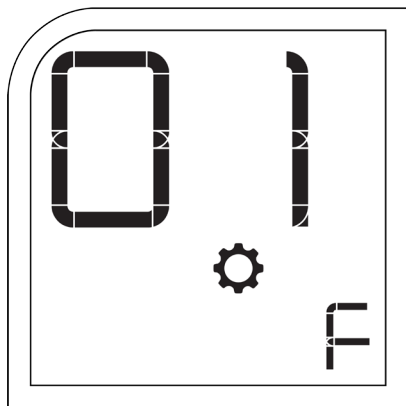

F for Fahrenheit

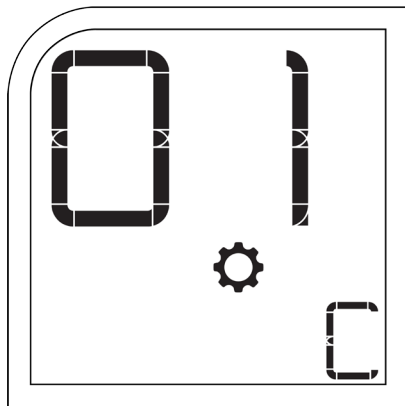

C for Celcius

-02 Temperature Calibration

KONO Smart is factory calibrated, but you can use this setting to adjust the temperature sensor for your home. The screen will alternate between your calibration temperature and the offset value - to remove calibration, make sure that the offset value is set to 0.

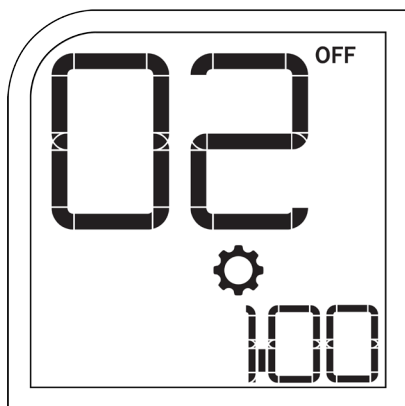
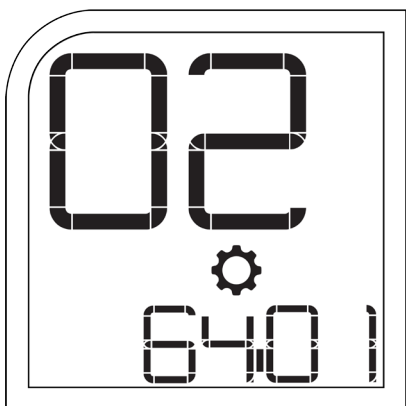

-03 Available HVAC Modes

KONO Smart uses terminal detection to identify your system type and you can use this installation setting to view and change the available modes. Use this setting to view and/or change the different modes available depending on your system type. Rotate the knob to see various options and configurations for your system.

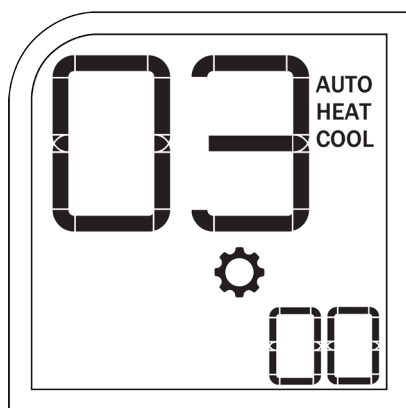

Auto Heat & Cool

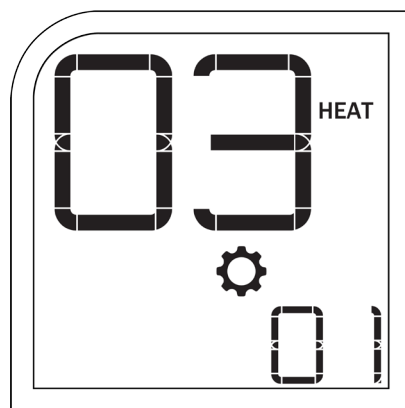

Heat Only

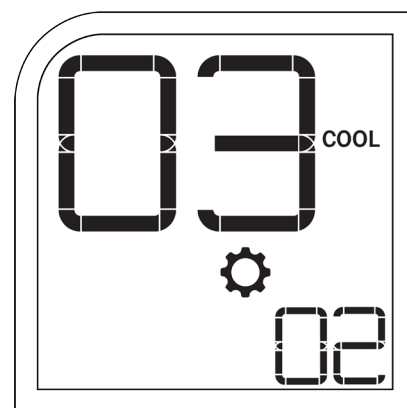

Cool Only

-04 Heat Limit

Use this setting to set a maximum temperature limit for your heating system. The limit can be as high as 90F (32C) or as low as 60F (15C).

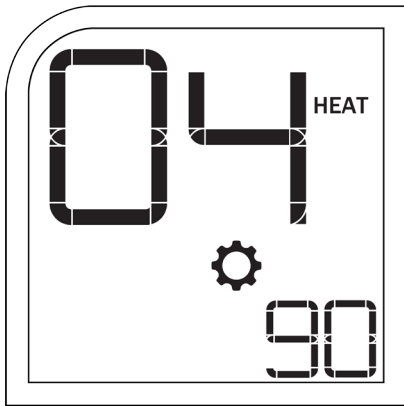

Maximum Heat Limit

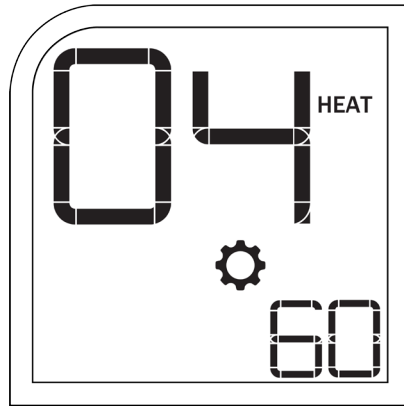

Minimum Heat Limit

-05 Cool Limit

Use this setting to set a minimum temperature limit for your cooling system. The limit can be as high as 75F (24C) or as low as 45F (7C).

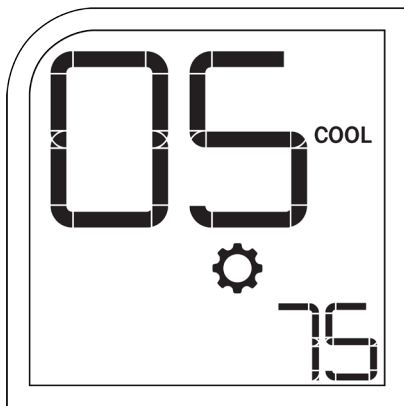

Cool Maximum

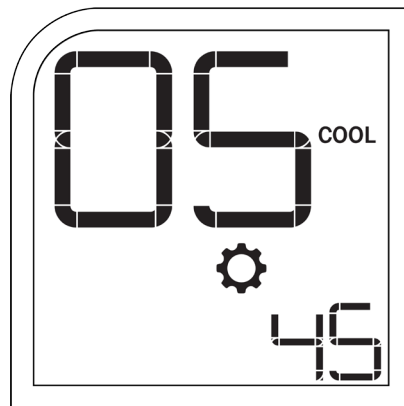

Cool Minimum

-06 System Type

Use this setting to modify the system type. The available options include Gas Furnace, Electric Furnace, Boiler (No Fan) and Heat Pump. See step 07 below for additional options when selecting Heat Pump.

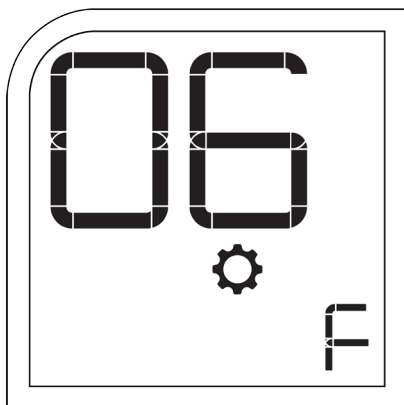

Gas Furnace

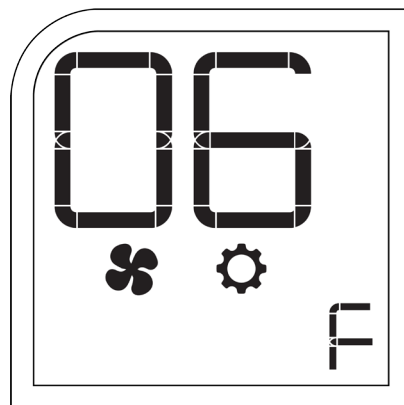

Electric Furnace

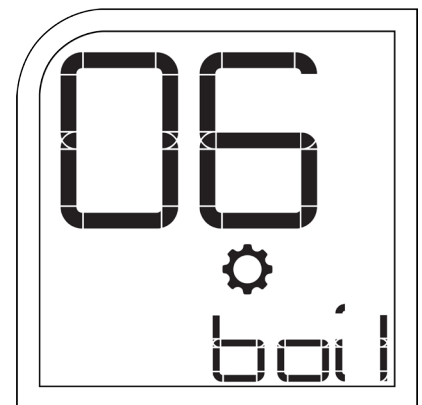

Boiler (No Fan)

-07 System Type - Heat Pump

If you selected heat pump during #6, you will then have to select your valve type in #7. Select O or B depending on your valve type. B will energize the B/O terminal in heat mode and O will energize the B/O terminal in cool mode.

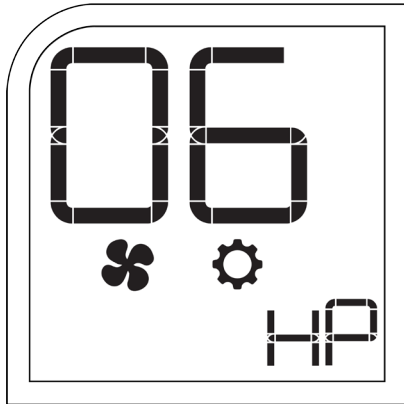

Heat Pump option

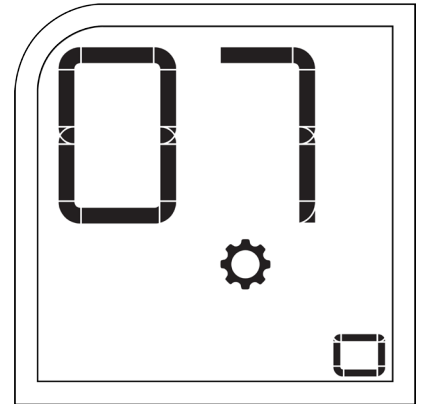
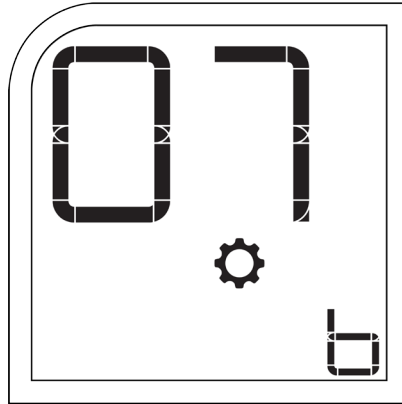

-08 Minimum On/Off Time

Use this setting to set a standby time so that your HVAC systems can safely and efficiently switch on and off. You can either select a 5-minute or a 2-minute off time. During normal operation, the hourglass icon indicates that the minimum off time is temporarily preventing your heating and cooling system from turning on.

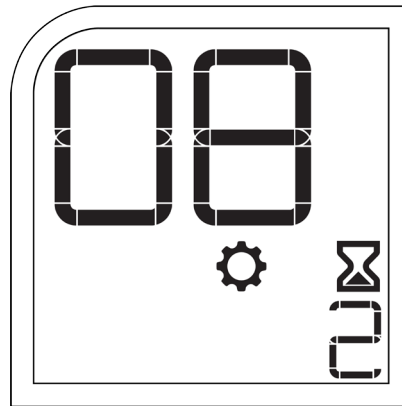
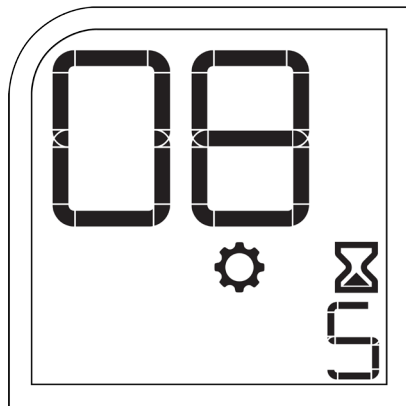

-09 Temperature Swing

Use this setting to set a swing value. Your swing setting determines how far the ambient temperature can deviate from the set temperature before KONO Smart turns on your heating or cooling system. You can select 0, .25°, .5°, 1° or 2.25°.



-

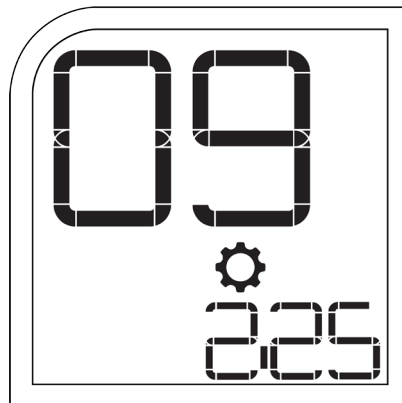

-10 Stage 2 Heating Offset (for conventional systems)

Use this setting to set a value that your thermostat will use to decide when to turn on your second stage of heating. You can select Off, 1, 2, 3, 4 or 5.

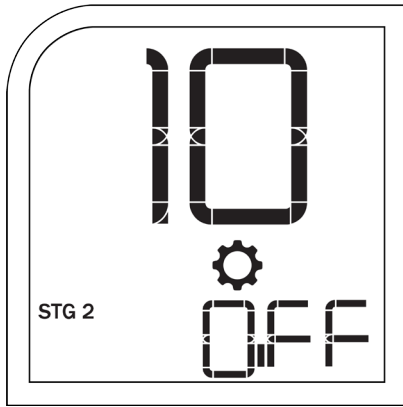

Off, no second stage heat

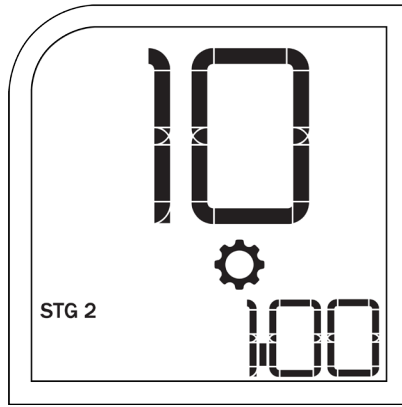

1°

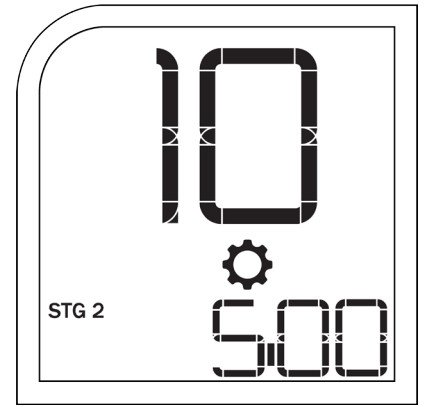

5°

-11 Stage 2 (Auxiliary) Heating Offset (for heat pump systems)

Use this setting to set a value that your thermostat will use to decide when to turn on your second stage of heating. You can select Off, 1, 2, 3, 4 or 5.

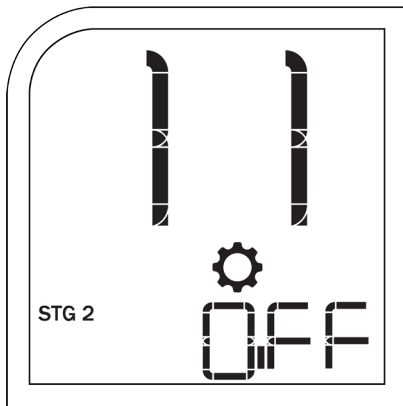

Off, no second stage heat

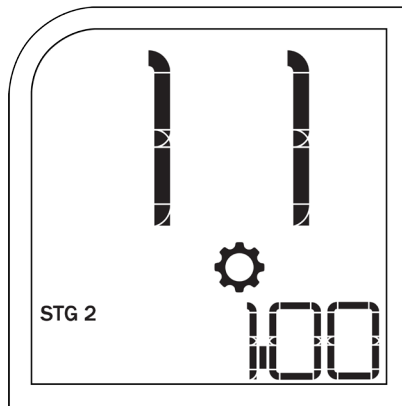

1°

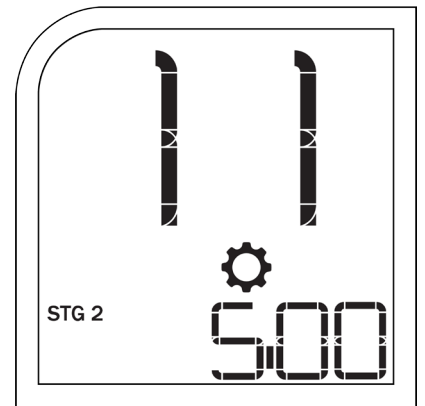

5°

-12 Clock Offset

Use this setting to choose between 12-hour am/pm time display or 24-hour time display.

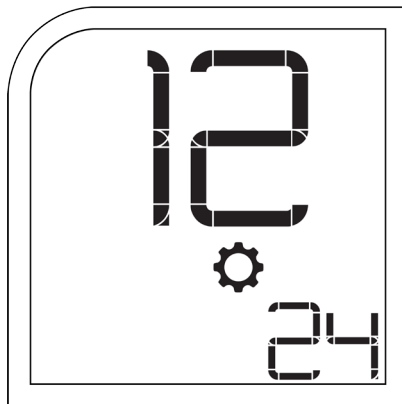
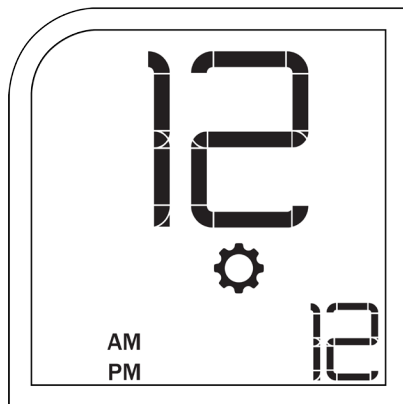

-13 Backlight

Use this setting to choose between a backlight auto-off setting of 10 seconds or an always-on backlight. When the backlight is turned off the display will not be visible. Press the knob to turn on the display.

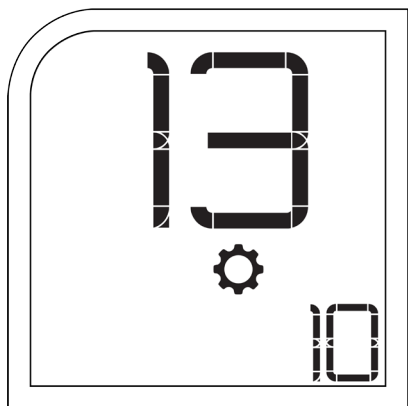

10 Seconds

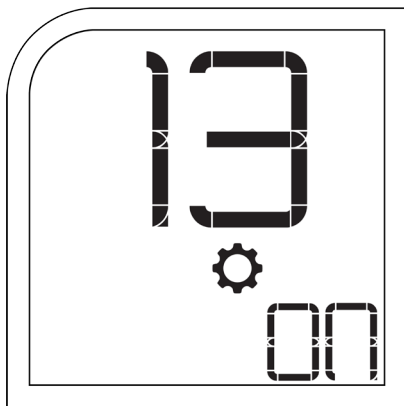

Always On

-14 Dual Fuel (for heat pump systems)

Use this setting to turn the 'Dual Fuel' option ON or OFF. When set to ON, the balance points defined in menus 15 and 16 will be used to determine use of compressor and auxiliary heat stages. When set to OFF, the outside air temperature will not be used to determine staging rules.

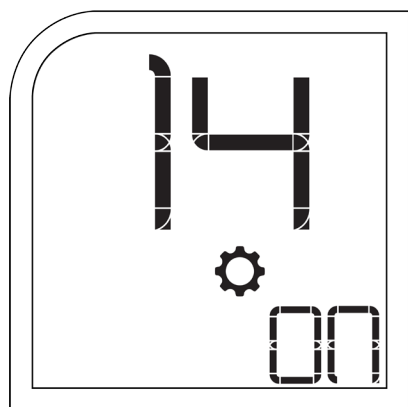

Dual Fuel On

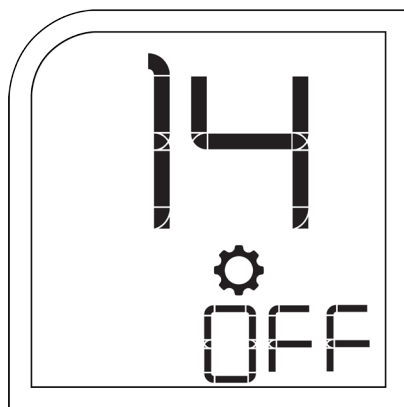

Dual Fuel Off

-15 Balance Point High

Use this setting to specify an outdoor air temperature above which your auxiliary heat source will be disabled. If the outdoor temperature goes above this set point, only the compressor heat source will be used.

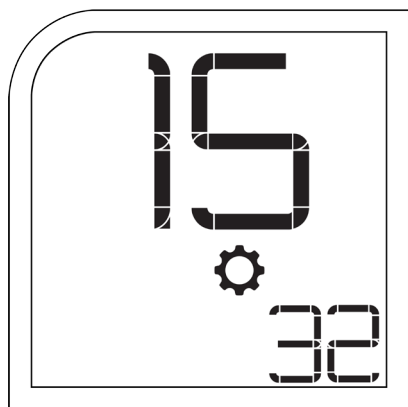

32°F (0°C)

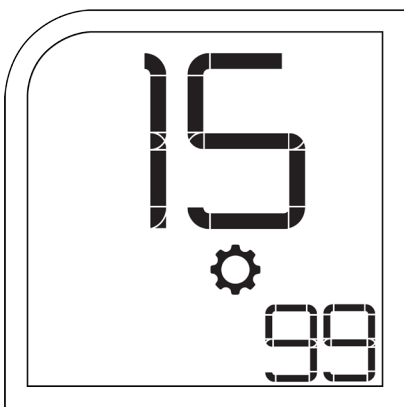

99°F (37°C)

-16 Balance Point Low

Use this setting to specify an outdoor air temperature below which your compressor will be disabled. If the outdoor temperature goes below this set point, only the auxiliary heat source will be used.

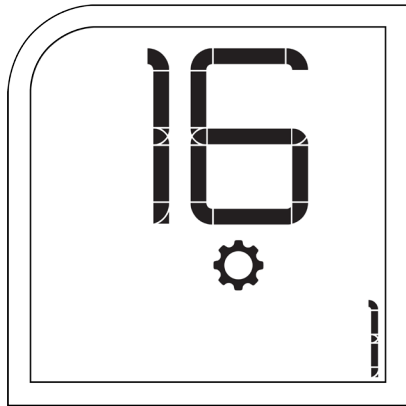

1°F (-18°C)

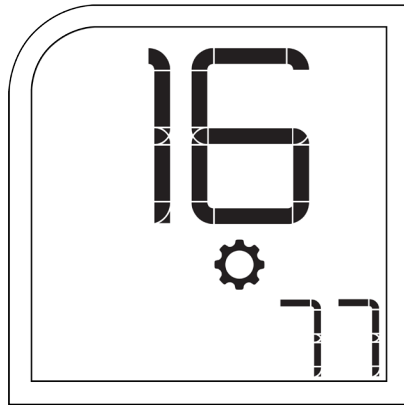

77°F (25°C)

-17 Filter Life

Use this setting to turn on and set a value for your air filter's lifespan. You'll then be able to check its remaining lifespan in the fan settings submenu. (You can select Off, 30, 60, 90, 120, 180 or 365 days).

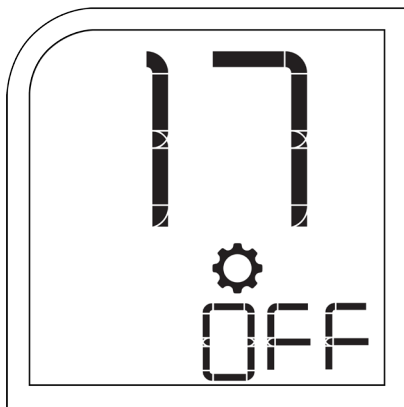

Off

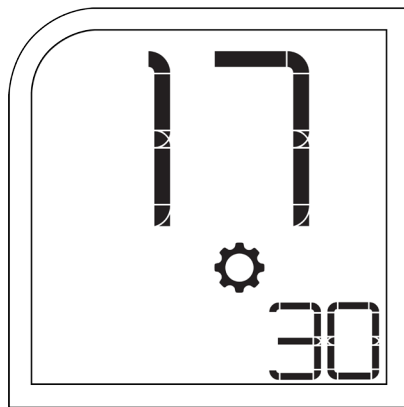

30 Days

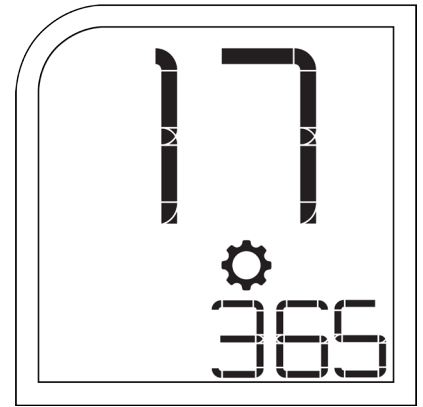

365 Days

-98 Compressor Bypass

Use this setting to temporarily disable the minimum on/ off time protection. If you set compressor bypass protection to 'yes' then your system will switch heating and cooling on/off without waiting for the minimum on/off time.

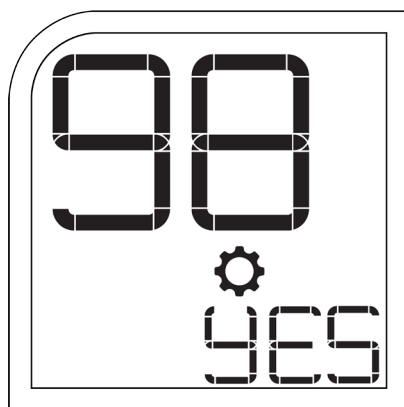

Compressor Bypass On

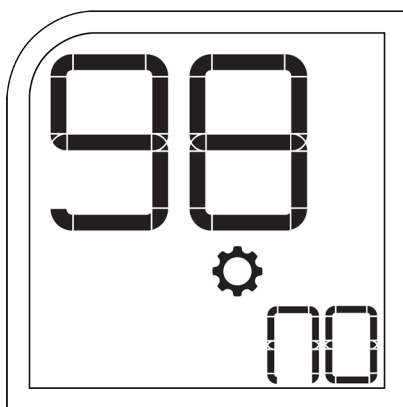

Compressor Bypass Off

-99 Factory Reset

Use this setting to initiate a factory reset and to setup your KONO Smart from scratch.

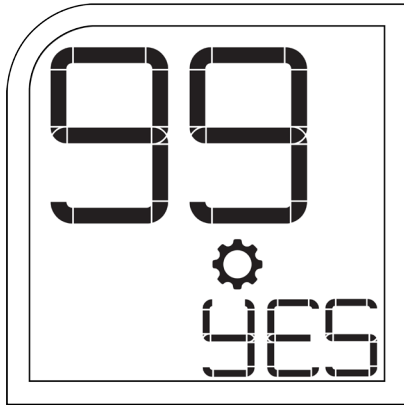

Reset KONO

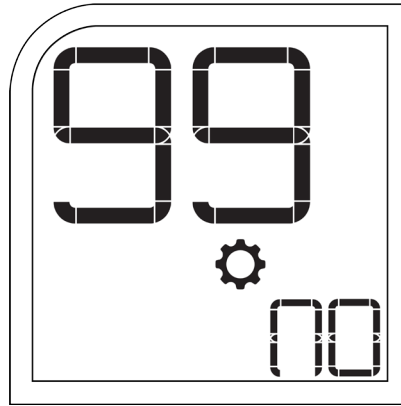

Do Not Reset KONO

-Additional Features

Lock: Press and hold the knob for 10 seconds on the main run screen to lock local control of KONO Smart. When locked, press and hold the knob for 10 seconds to unlock.

Power Cycle: Remove KONO Smart from its base and locate the black reset button on the back of the thermostat. Press and hold this button for 3 seconds to fully power cycle the device.

EMER Heat: If you have a Heat Pump system with stage 2 (auxiliary) heat enabled, you can select EMER heat from the mode menu. When this is enabled, the thermostat will not use the compressor heating stage and will use the auxiliary heating stage as the only heat source.

For wiring diagrams, please reference the appendix section of the [KONO Smart Installation Manual](#)

We're here to help! Please contact our customer support team for assistance:

PHONE: 856.234.8803
LIVE CHAT: [LuxProducts.com/support](https://luxproducts.com/support)
EMAIL: techsupport@luxproducts.com
VIDEOS: [LuxProducts.com/Videos](https://luxproducts.com/Videos)
SUPPORT HOURS: 8am to 6pm EST, Monday - Friday